

# CATALOGUE

ALPS® PROSTHETIC SOLUTIONS



2025 NEW PRODUCT SHOWCASE WINNER  
AOPA NATIONAL ASSEMBLY



# ALPS SOUTH

## LINER SPECIALISTS SINCE 1993

ALPS South is an American company which has been specializing in the production of prosthetic liners since 1993. Since then we have expanded globally, with offices in 5 countries, a consolidated network of agents and over 270 trusted distributors spread out all over the world.

Thanks to our dedication to innovation, coupled with our eagerness to interpret and even anticipate the needs of prosthetic technicians and wearers, ALPS has gone far beyond our initial production only of prosthetic liners, and developed a whole range of high-quality prosthetic solutions, including more than 75 registered patents spanning an array of product categories. This catalogue makes it easy to access information about the entire range of ALPS products to identify the best prosthetic solutions based on both the lifestyle and clinical profile of each individual patient.

### PREMIUM QUALITY 100% MADE IN USA

Investment in innovation, research and quality, both in terms of products and working methods, continues to be a priority here at ALPS, allowing us to offer premium solutions. The entire production process, from the knitting of fabrics to the manufacturing of the liners, takes place at our St. Petersburg, Florida plant. This means we can assure maximum quality control at every step of production. In addition ALPS guarantees the quality and safety of its products with certification from some of the most important internationally recognized authorizing institutions. ALPS has been manufacturing FDA-approved medical devices since 1989. ALPS products are designed and produced according to ISO13485 and GMP (Good manufacturing practice) standards, meeting the requirements of the EU regulations CEE 93/42 UE and conforming to MDR 2017/745.





# ALPS SOUTH

## MAKING LIVES BETTER™

“Making Lives Better™” is the mission which has been driving the company since 1988, inspiring our job every day and pushing us to provide superior products for you and for every prosthetics user.

We pride ourselves on our fair business practices with customers, vendors, and employees alike, while maintaining a brand image that makes our staff, collaborators and end-users of our products all proud to be associated with ALPS.

### USERS FIRST

**When it comes to optimizing prosthetic fit and patient outcomes, liner selection plays a critical role.** With a combination of five elastomers, five fabrics, and five suspension options, ALPS offers one of the most versatile and high-performing liner portfolios on the market, designed to meet the diverse needs of patients and technicians.

Throughout the catalog, you'll find a QR code that links to a simple, easy-to-understand overview of the prosthetic liner technologies we offer. This webpage will offer helpful explanations of each elastomer, fabric, and suspension type, empowering you to make informed decisions and select the most appropriate liner solution for every patient.

ALPS® Liner Technology

---

5 Elastomers. 5 Fabrics. 5 Suspensions.



# INDEX CATALOGUE

<b>LINERS OVERVIEW</b> .....	12
<b>SLEEVES OVERVIEW</b> .....	18
<b>OUR TECHNOLOGIES</b> .....	22
GEL TECHNOLOGY .....	24
OPTIGEL TECHNOLOGY .....	26
KNITTING TECHNOLOGY .....	28
SILICONE TECHNOLOGY .....	30
NRG TECHNOLOGY® .....	32
DISTAL END TECHNOLOGY .....	34
LINER TECHNOLOGY .....	38
<b>HOW ANTIOXIDANTS WORK</b> .....	40
CASE STUDIES .....	41
<b>PROSTHETIC LINERS</b> .....	44
SoftSil Liner .....	46
Pro-Fit Liner .....	48
UltraSeal Silicone Liner .....	50
UltraSeal Gel Liner .....	52
EasyLiner® .....	54
Silicone Pro Liner .....	56
Superior Performance Liner .....	58
Superior Performance HD Liner .....	60
General Purpose Liner .....	62
Eco™ Liner .....	64
Smart Seal™ Liner .....	66
Extreme™ Liner .....	68
Extreme™ HD Liner .....	70
EasyFlex™ Liner .....	72

EasyLiner® SuperStretch .....	74
Anterior Posterior Tapered Liner .....	76
PSI Liner .....	78
Liberty™ Liner .....	80
<b>PROSTHETIC SUSPENSION SYSTEMS .....</b>	<b>82</b>
<b>SLEEVES</b>	
Reinforced Flex Sleeve .....	84
Reinforced Sleeve .....	86
EasySleeve .....	88
EasySleeve SuperStretch .....	90
Flex Sleeve .....	92
Superior Suspension Sleeve .....	94
Superior Performance Sleeve .....	96
Extreme Sleeve .....	98
EasySleeve Fabric Reinforced .....	100
<b>LOCKS</b>	
Lock with Pyramid .....	102
Lock with Flat Bottom .....	104
VIP® Lock .....	106
<b>ELEVATED VACUUM</b>	
Vacuum Integrated Pump .....	108
<b>ADDED SOLUTIONS .....</b>	<b>110</b>
<b>MODULAR COMPONENTS</b>	
Tubes, adapters, receivers .....	112
<b>VOLUME CHANGE MANAGEMENT</b>	
Prosthetic Socks with Hole .....	114

# INDEX CATALOGUE

Prosthetic Socks without Hole .....	116	
Skin Reliever .....	118	
<b>LINER AND RESIDUAL LIMB CARE</b>		
Antioxidant Cream .....	120	
Silicone Skin Lotion .....	121	
Prosthetic Lubricant .....	122	
Prosthetic Cleanser .....	123	
<b>EXTRA</b>		
PadSil .....	124	
<b>PROSTHETIC FEET</b> .....		126
BioStep® EVO .....	128	
BioStep® PRO .....	130	
BioStep® CL .....	132	
BioStep® XT .....	134	
BioStep® LP .....	136	
<b>PROSTHETIC KNEE</b>		
ProStride .....	138	
<b>HOW TO SIZE LINERS AND SLEEVES</b> .....		140
<b>ALPS WARRANTY POLICY</b> .....		142
<b>CONTACTS</b> .....		144





# PRODUCT SYMBOLS

## SUSPENSION



Locking Liner



Cushion Liner

## MATERIAL



**EASYGEL**

Gel rich in antioxidants and characterized by a soft, powdery texture



**GRIPGEL**

Gel with a smooth, tacky texture



**HIGH DENSITY GEL**

Gel with a dense, firm texture



**OPTIGEL**

Exclusive white gel with a soft, smooth texture



**SILICONE**

Comfortable hypoallergenic silicone



**OPTISIL**

Advanced medical-grade white silicone

## ACTIVITY LEVEL



K1: low activity



K2: middle/low activity



K3: middle/high activity



K4: high activity

## FABRIC



In-house knitted fabric with high quality yarns



Black Fabric with highly reduced vertical stretch



Brown Fabric with reduced vertical stretch









Beige Fabric with both horizontal and vertical stretch





















Gray Fabric with increased reduction of vertical elongation

# LINERS OVERVIEW

PICTURE	NAME	PART #	SUSPENSION	MATERIAL
	SoftSil Liner	SSGSL SSGSC		 OptiSil
	Pro-Fit Liner	PFGDT PFGFR		 OptiGel
	UltraSeal Silicone	USHSL USHSC USLSL USLSC USUSL USUSC		 OptiSil
	UltraSeal Gel	USHGL USHGC USLGL USLGC USUGL USUGC		 OptiGel
	EasyLiner®	ELDT ELFR		 EasyGel
	Silicone Pro Liner	LSC LSL		 Silicone
	Superior Performance Liner	SPDT SPFR		 GripGel















THICKNESS	ACTIVITY LEVEL	RECOMMENDED FOR	PAGE
 2 mm	 K1  K2 ✓  K3 ✓  K4 ✓	Patients with medium to high activity levels as the fabric offers a high degree of control, while the soft silicone provides comfort. Further recommended for patients living in hot areas.	46
 3 mm    6 mm	 K1  K2 ✓  K3 ✓  K4 ✓	Patients who demand comfort, control, and stability needed for high performance activities.	48
 2 mm	 K1 ✓  K2 ✓  K3 ✓  K4 ✓	Transtibial and transfemoral users with medium to long residual limbs and for knee disarticulation.	50
 3 mm	 K1 ✓  K2 ✓  K3 ✓  K4 ✓	Transtibial and transfemoral users with medium to long residual limbs and for knee disarticulation.	52
 3 mm    6 mm    3/6 mm <small>9mm only available in sizes 24 and 28; size 35 available only in 3mm and 6mm.</small>	 K1 ✓  K2 ✓  K3 ✓  K4 ✓	Diabetic patients and those with sensitive skin and whenever the comfort and the protection of the residual limb is a priority.	54
 2 mm	 K1 ✓  K2 ✓  K3 ✓  K4 ✓	Residual limbs with redundant soft tissue and for transfemoral amputees. Further recommended to counter perspiration issues and for patients living in hot areas.	56
 3 mm    6 mm	 K1 ✓  K2 ✓  K3 ✓  K4	Transfemoral and transtibial patients with moderate activity levels, and good skin condition who are looking for an improved control of the prosthetic leg.	58

# LINERS OVERVIEW











PICTURE	NAME	PART #	SUSPENSION	MATERIAL
	<b>Superior Performance HD Liner</b>	SPDTHD SPFRHD		 High Density Gel
	<b>General Purpose Liner</b>	GPDT GPFR		 GripGel
	<b>Eco™ Liner</b>	ECDTHD ECFRHD		 High Density Gel
	<b>Smart Seal™ Liner</b> For hypobaric suspension	SADT SAFR SBFR		 High Density Gel
	<b>Extreme™ Liner</b>	AKDT AKFR		 GripGel
	<b>Extreme™ HD Liner</b>	AKDTHD AKFRHD		 High Density Gel

THICKNESS	ACTIVITY LEVEL	RECOMMENDED FOR	PAGE
 3 mm    6 mm	 K1    K2 ✓    K3 ✓    K4 ✓	<p>Patients with medium and high activity levels who require both comfort and elevated levels of control of the prosthetic leg. It is also recommended for patients whose residual limbs have excessive soft tissue and for transfemoral amputees.</p>	60
 3 mm    6 mm	 K1 ✓    K2 ✓    K3 ✓    K4 ✓	<p>Patients with low activity levels and good skin conditions; it is also indicated for irregularly shaped residual limbs and those with bony protuberances.</p>	62
 3 mm    6 mm	 K1 ✓    K2 ✓    K3 ✓    K4 ✓	<p>Patients with medium to high activity levels, whether with transtibial or transfemoral prostheses, and for those whose residual limbs present redundant soft tissues.</p>	64
 3 mm    6 mm	 K1 ✓    K2 ✓    K3 ✓    K4 ✓	<p>Transtibial and transfemoral users with medium to long residual limbs and for knee disarticulation.</p>	66
 3 mm    6 mm	 K1 ✓    K2 ✓    K3 ✓    K4	<p>Patients, both transfemoral and transtibial, with medium activity levels whose skin is in good condition and who are aiming to maintain a good level of control of the prosthetic leg.</p>	68
 3 mm    6 mm	 K1    K2 ✓    K3 ✓    K4 ✓	<p>Patients with medium and high activity levels as it offers a high level of control while preserving comfort. It is also recommended for patients whose residual limbs have excessive soft tissue and for transfemoral amputees.</p>	70

# LINERS OVERVIEW

PICTURE	NAME	PART #	SUSPENSION	MATERIAL
	EasyFlex™ Liner	EZF		 EasyGel
	EasyLiner® SuperStretch	ELPX		 EasyGel
	Anterior Posterior Tapered Liner	APDT APFR		 High Density Gel
	PSI Liner	PSI		 EasyGel
	Liberty™ Liner	VSDT		 High Density Gel











THICKNESS	ACTIVITY LEVEL	RECOMMENDED FOR	PAGE
 3 mm    6 mm	 K1 ✓    K2 ✓    K3 ✓    K4 ✓	It is recommended for diabetic and sensitive skin transtibial patients who have medium to high activity levels and using a pin and lock suspension.	<b>72</b>
 6 mm	 K1 ✓    K2 ✓    K3    K4	It is recommended for diabetic patients and those with sensitive skin or irregularly shaped residual limbs.	<b>74</b>
 AP tapered	 K1 ✓    K2 ✓    K3 ✓    K4 ✓	It is indicated for transtibial users with medium and high activity levels who desire greater control and freedom of movement without sacrificing comfort.	<b>76</b>
 6 mm    6/3 mm	 K1 ✓    K2 ✓    K3    K4	It is recommended for transtibial patients with low and medium activity levels and sensitive skin.	<b>78</b>
 3 mm    6 mm	 K1 ✓    K2 ✓    K3 ✓    K4 ✓	It is recommended to counter the problem of excessive perspiration.	<b>80</b>

# SLEEVES OVERVIEW

PICTURE	NAME	PART #	MATERIAL	THICKNESS	
	Reinforced Flex Sleeve	RFX	 OptiGel	 3 mm	
	Reinforced Sleeve	RFS	 OptiGel	 3 mm	
	EasySleeve	SFR	 EasyGel	 3 mm 6 mm	
	EasySleeve SuperStretch	SLE	 EasyGel	 6 mm	
	Flex Sleeve	SFX	 HD Gel	 3 mm	
	Superior Suspension Sleeve	SFB SFBHD	 HD Gel	 GripGel	 2 mm
	Superior Performance Sleeve	SFP SFPHD	 HD Gel	 GripGel	 3 mm 6 mm

KEY FEATURES	ACTIVITY LEVEL	PAGE
30° pre-flexion + an added layer of internal fabric for increased durability	 K1  K2 ✓  K3 ✓  K4 ✓	84
Constructed with an extra layer of internal fabric to deliver superior durability	 K1  K2 ✓  K3 ✓  K4 ✓	86
For sensitive skins	 K1 ✓  K2 ✓  K3 ✓  K4 ✓	88
Without fabric for freedom of movement	 K1 ✓  K2 ✓  K3  K4	90
30° pre-flexed	 K1 ✓  K2 ✓  K3 ✓  K4 ✓	92
2 mm thinner profile for less bulk	 K1 ✓  K2 ✓  K3 ✓  K4 ✓	94
The innovative black fabric provides comfort and stability	 K1 ✓  K2 ✓  K3 ✓  K4 ✓	96

# SLEEVES OVERVIEW

PICTURE	NAME	PART #	MATERIAL	THICKNESS
	<b>Extreme Sleeve</b>	SFK	 GripGel	  3 mm 6 mm
	<b>EasySleeve Fabric Reinforced</b>	SFS	 GripGel	  3 mm 6 mm

**KEY FEATURES**

**ACTIVITY LEVEL**

**PAGE**

Limited vertical stretch, ideal for active patients



98

Achieves secure suspension by sealing with the skin without restricting circulation



100

# OUR TECHNOLOGIES

Gel Technology  
OptiGel Technology  
Knitting Technology  
Silicone Technology  
NRG Technology®  
Distal End Technology  
Liner Technology





## GEL TECHNOLOGY



**ALPS expertise in the field of chemistry and our position as a leading manufacturer of advanced gel-based medical devices have led to the development of a wide range of prosthetic liners and sleeves over the years, characterized by an innovative and unique product: our patented gel.**

ALPS Gel offers an optimum level of protection against shear forces and other stresses, guaranteeing the perfect combination of control and uniform distribution of pressure within the socket thanks to its characteristic low modulus of elasticity.

ALPS Gel is far more flexible and resistant with respect to other gels being used in the lower limb prosthetic liner industry. ALPS Gel offers up to six times the elasticity of other gels on the market. It is this important mechanical property that allows ALPS Gel to guarantee prosthetic leg wearers the comfort, durability, control and safety they need to grant them the mobility and freedom of movement.







## Four types of ALPS Gels to serve the mobility needs of prosthetic leg wearers

ALPS makes four types of gels to meet the needs of every individual prosthetic leg user whose requirements vary based on their clinical condition and lifestyle : EasyGel, GripGel, HD Gel and OptiGel. The full range of ALPS Gels means that each patient will be able to find his or her own, unique, perfect comfort.



### EASYGEL

Soft, powdery texture. It is rich in antioxidants that are an effective scavenger of free radicals and hydroxyl groups. Best for use on amputees with adherent scar tissue, skin irritations, sensitive skin and diabetics.



### HIGH DENSITY GEL

Dense, firm texture. Relatively firm nature of the HD Gel combines comfort with control and stability. Recommended for highly active users who are transitioning from a silicone liner to a gel liner.



### GRIPGEL

Smooth, tacky texture. Tackiness helps in reducing bunching in the popliteal area. Recommended for users with healthy skin tissue.



### OPTIGEL

Exclusive, white gel. Excellent adhesion to the residual limb. Recommended for users who demand ultimate comfort, control, and stability.

# OPTIGEL TECHNOLOGY

**OptiGel represents a next generation of gel developed for unmatched comfort, stability, and protection.**

OptiGel's gentle yet durable formulation enhances the patient experience by reducing pressure, friction, and impact forces, while its compact structure provides excellent strength and stability, improving overall movement control.

## CLINICAL BENEFITS



Provides superior comfort and skin protection



Minimizes pressure, friction, and impact



Improves stability and movement control



Adapts to volume changes for a secure fit



Ensures greater durability, also for highly active users

**TRUSTED PERFORMANCE.  
PREMIUM RESULTS.**



## Explore all OptiGel product solutions.

LINERS	Product Name	Suspension	Thickness	Activity Level	Description
<p>SEALING TECHNOLOGY</p>	UltraSeal Gel Liner		3 mm		<p>Integrates advanced sealing technology with the benefits of gel to provide exceptional comfort and conformity to the residual limb.</p> <p>Available in three ring heights: Ultra Low, Low, High</p>
	Pro-Fit Liner		3 mm 6mm		<p>Provides gentle skin contact and a secure fit around the residual limb.</p>

### \* LOCKING STYLE: U-BAND

In combination with the U-band in the locking versions, OptiGel helps reduce pistoning without any distal-end constriction.

SLEEVES	Product Name	Thickness	Activity Level	Description
	Reinforced Flex Sleeve	3 mm		<p>Built with an added layer of internal fabric to offer increased durability around the trim line of the user's socket.</p> <p>Provides a 30° pre-flexion to ease bending and reduce bunching behind the knee.</p>
	Reinforced Straight Sleeve	3 mm		<p>Constructed with an extra layer of internal fabric to deliver superior durability.</p> <p>Provides maximum comfort, control, and high-performance.</p>

## KNITTING TECHNOLOGY



**The choice of fabric used for producing prosthetic sleeves and liners is fundamental for guaranteeing maximum comfort and safety.**

This is why ALPS began manufacturing its own fabrics years ago: to be sure to offer a product that best meets the functional needs of prosthetic wearers. The fabric needs to do more than just protect the materials used in making the liners and extend their durability; it must also be able to generate a greater, lesser or differentiated level of tension depending on the needs of the individual user. ALPS manufactures and uses five types of fabric: grey, beige, brown, black and knitted.

These five types of fabric are not differentiated merely by color and manufacturing process, they also each have distinctive characteristics and functions in order to provide each prosthetic leg wearer with the specific benefits he or she needs based on individual lifestyles and clinical conditions.



### **BEIGE FABRIC**

#### **Beige fabric stretches both vertically and horizontally**

The fabric's stretch allows the liner to adapt to the shape of the residual limb as it moves to guarantee maximum comfort.



### **BROWN FABRIC**

#### **Brown fabric has reduced vertical elasticity**

Vertical stretch is reduced by 80% compared to the beige fabric, allowing a greater level of control and stability of the prosthesis. Ideal for active patients.



### **BLACK FABRIC**

#### **Black fabric with greatly reduced vertical stretch**

Vertical stretch is 90% lower than the beige fabric, allowing a greater level of control and stability of the prosthesis. Ideal for active patients.



### **GREY FABRIC**

#### **Grey fabric with increased reduction of vertical stretch**

Minimal vertical stretch allows for a high level of control and freedom of movement. Ideal for active patients.



### **KNITTED FABRIC**

ALPS years of experience in manufacturing fabrics has played a fundamental role in the development of our latest innovation: products created using ALPS knitted fabric.

Our latest fabric manufacturing process has allowed us to:

- Create products totally devoid of any stitching
- Maintain control of the tension in each section of the liner to maximize and reduce the effects of pistoning
- Integrate a matrix in the distal construction of our locking liners
- Integrate a distal matrix to limit elongation / U matrix or Regular Matrix

# SILICONE TECHNOLOGY

## ALPS<sup>®</sup> has introduced innovative and skin-friendly silicone prosthetic liners for lower limb amputation.

These liners provide a solution to some of the clinical problems and disadvantages of silicone in skin-contact applications due to the inherently high coefficient of static friction typical of silicone polymers.

ALPS expertise in processing silicone allowed our engineers to come up with a new manufacturing method which improved the friction characteristics of the silicone prosthetic liner.

The surface of the prosthetic liner has been modified, to create micro craters that reduce the static friction without any additives, resulting in a completely skin friendly silicone.

Silicone with the modified surface layer shows a reduction of 80% of the coefficient of static friction, as shown in the graph below.

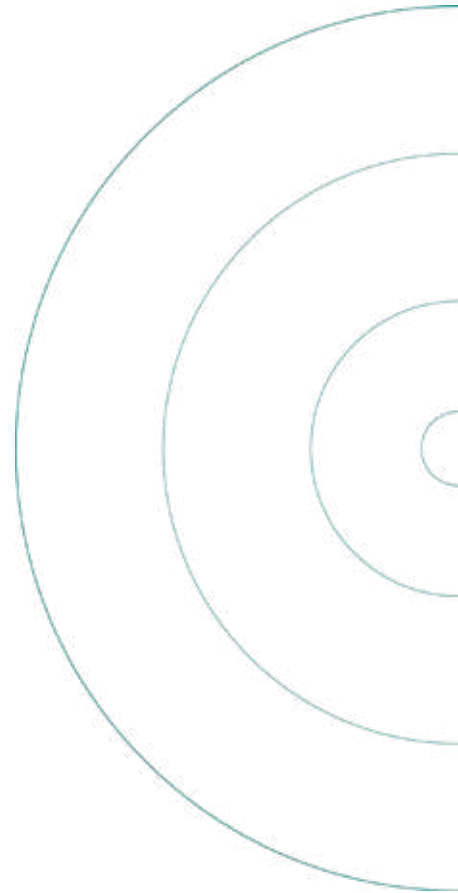

### FRICION TESTING

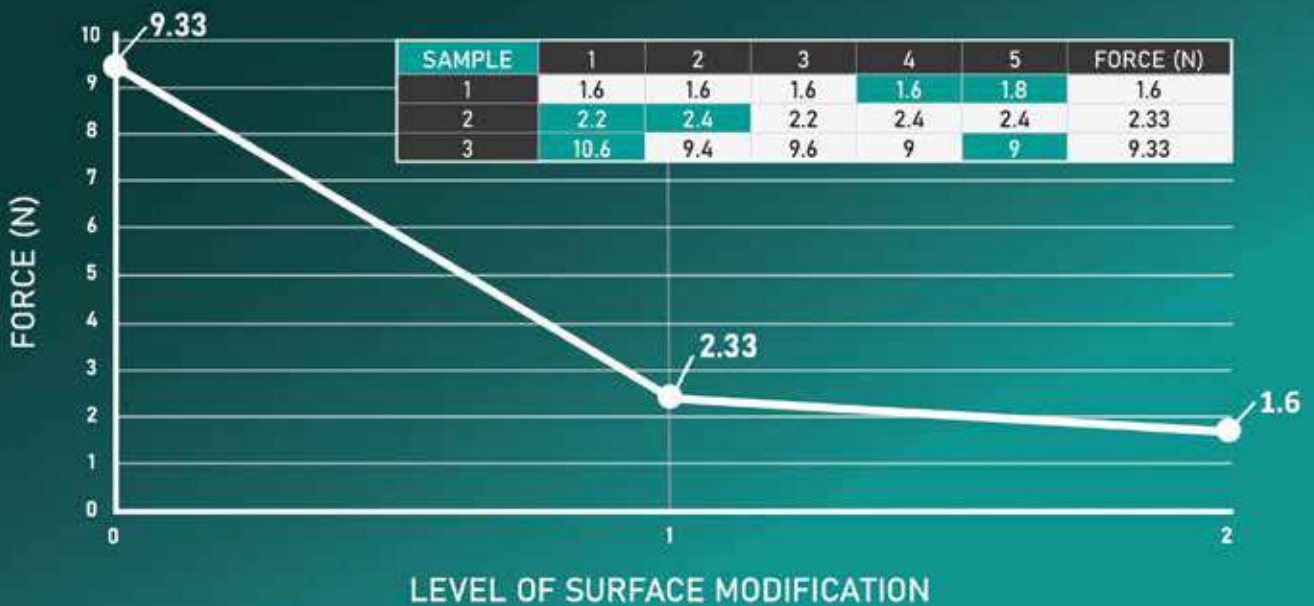



**ALPS makes two types of silicone to meet the needs of every individual prosthetic leg user.**



**SILICONE:** Comfortable Hypoallergenic Silicone. 1/5 the friction of standard silicone, and completely free from additives. Recommended for users looking for a silicone liner very delicate on the skin.



**OPTISIL:** Advanced Medical-Grade White Silicone. All features of ALPS Silicone while achieving an enhanced balance of control and comfort; maintains the skin moisturized, cool, and healthy. Recommended for medium and high-activity users who demand ultimate comfort, stability, and support for the skin's natural thermoregulation process.

ALPS silicone is lightweight, hypoallergenic, cool and additive-free and creates only one-fifth the friction of normal silicone. The technology used to create this particular silicone is of fundamental importance, allowing ALPS to design and produce silicone liners for prosthetic legs which can guarantee: freedom of movement, maximum gentleness on the skin, cooling effect and ease of cleaning



## Inspired by Nature. Empowered by Technology.

**NRG® - Natural Reactive Gait - is a patented innovative dynamic response foot technology designed to replicate the natural movement of the calf and shin muscles.**



**ONE FOOT,  
MULTIPLE POSSIBILITIES,  
INFINITE EMOTIONS**





## KEY FEATURES



Unique multilayer construction



Exclusive and patented reverse shank design



Advanced flexible ergonomic design

## KEY BENEFITS

- Physiological and energy efficient gait
- Smooth rollover during the whole gait cycle
- High dynamic response to support an active lifestyle
- Possibility to do a wide range of activities with just one single foot
- Ground compliance and stability on all terrains
- Reduction of secondary issues thanks to a more balanced posture and symmetrical gait
- Low maintenance
- Lightweight
- Waterproof



# DISTAL END TECHNOLOGY

**Our distal end construction delivers a superior, high-quality product that provides the comfort, protection, and durability essential for a successful prosthetic liner.**

## How we do it.

Our team of engineers works meticulously to ensure that every distal end is constructed to the highest standards, using only the best materials and components.

That's why our prosthetic liners are designed using an **internal distal end construction method** which fuses the three primary liner materials- gel, fabric, and umbrella- on the inside of the liner, instead of being glued on from the outside like many liners available today.

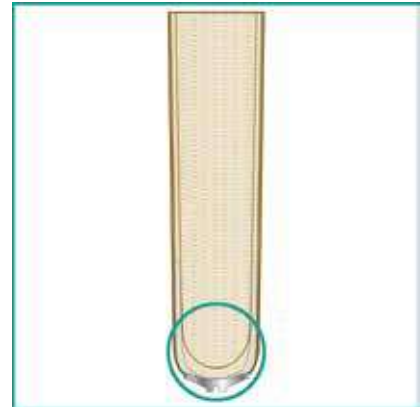

Integrating these materials into a cohesive unit creates a secure anchoring point for the umbrella, ensuring that the liner can easily connect to a prosthetic device without fear of damage or detachment. Not only does this guarantee the reliability of the entire system, but it also provides unparalleled comfort and performance.

## 4 distal end styles and 6 different construction processes.



EASYLINER



GP, AK, SP, EZF, VSDT



PRO-FIT



SOFTSIL & ULTRASEAL



SILICONE PRO

Each prosthetic liner falls under 1 of 4 distal end styles, which is determined by umbrella type. The liners within each style are then further grouped based on its internal construction process (i.e., the components used during assembly).

Each of the six construction processes is unique and complex, involving several elements that merge together to create a highly durable structure that caters to the liner's purpose and recommended use.

Refer to the Table on page 35 to view the specs of each distal end style and the components used in their construction.

Distal End Styles		Distal End Construction		Distal End Components			
Style Name	Umbrella Type	Internal Construction	Liner(s)/Construction Process	Grommet	Internal Reinforcement Fabric	U Band	Encapsulation
Easy	Wide, Flat	✓	EasyLiner	✓	✓		Plastic
Retro	Standard	✓	GP, AK, EZF, VSDT, SP	✓	✓		Silicone
			Eco	✓		✓	Silicone
Choice	Low-Profile	✓	Pro-Fit	✓		✓	Aluminum
			SoftSil			✓	Aluminum
			UltraSeal				
Classic	Low-Profile	✓	Silicone Pro			✓	

Gel and fabric type not included as it may vary.

## Deep Dive

Style: Choice Construction Process: Pro-Fit

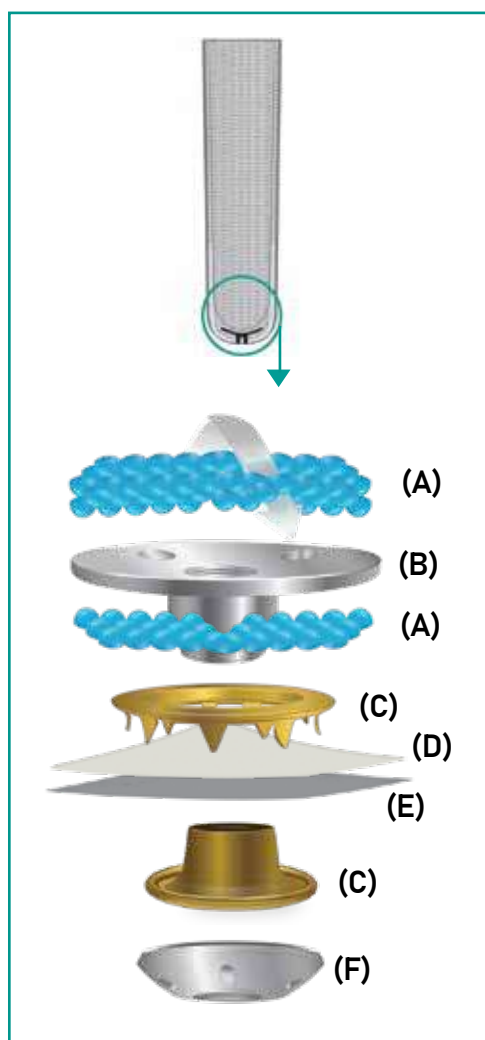

### A. Gel

The thickness layer of the OptiGel increases at the distal end to provide cushion. It also embeds the base of the umbrella (B) and helps secure the fabric layers (D, E) in place.

### B. Umbrella

An internal metal umbrella makes the liner more secure and durable, as opposed to umbrellas glued externally to the fabric.

### C. Grommet

The grommet links and secures both fabric layers together (D, E), forming a solid composite while providing a secure anchoring point for the umbrella.

### D. U Band

The U Band prevents distal pistoning while allowing for the expansion of bulbous residual limbs.

### E. External Fabric

The external fabric layer protects all internal elements and offers limited vertical stretch to provide a greater level of control and stability of the prosthesis.

### F. Encapsulation

The aluminum encapsulation provides a highly durable attachment point to the prosthetic.

# DISTAL END CONSTRUCTION



## EASYLINER

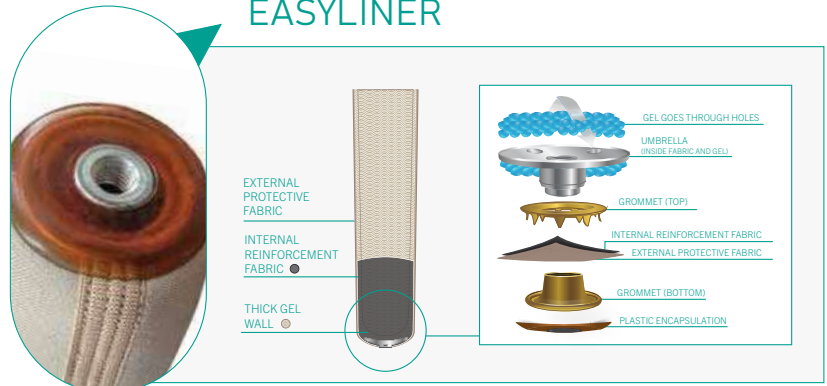

✓ Wide, Flat Encapsulation for Easy Donning

## SOFTSIL & ULTRASEAL LINER

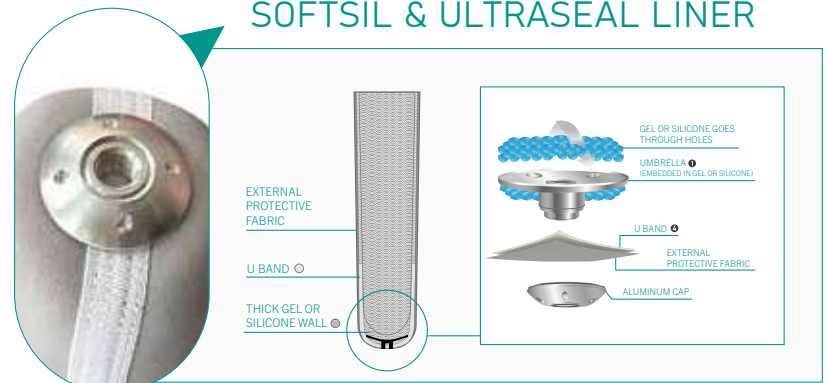

✓ Low-Profile Umbrella

✓ All Metal Construction<sup>®</sup>

## GP, AK, SP, EZF, VDST

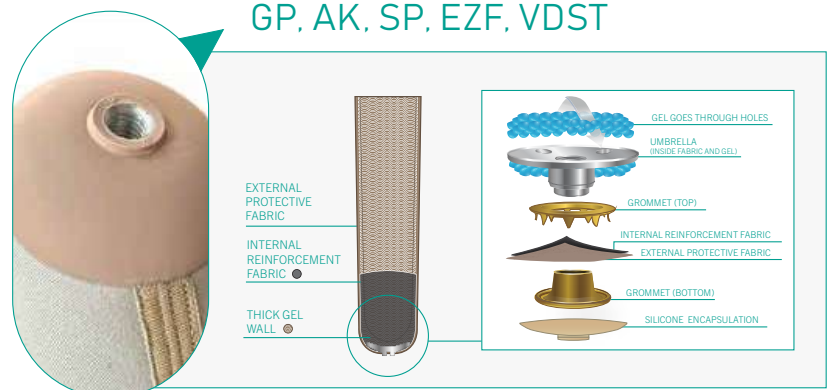

✓ Versatile Encapsulation

## PRO-FIT LINER

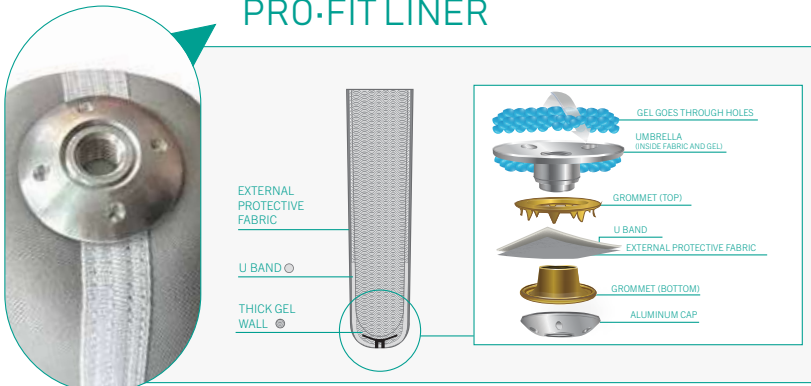

✓ Low-Profile Umbrella

✓ All Metal Construction

## ECO LINER

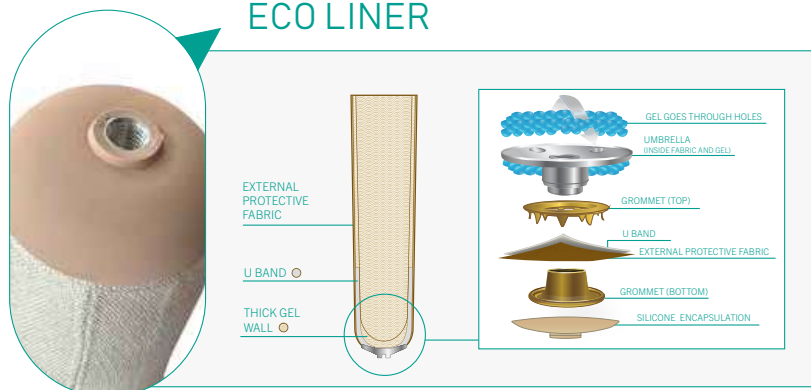

✓ Versatile Encapsulation

## SILICONE PRO LINER

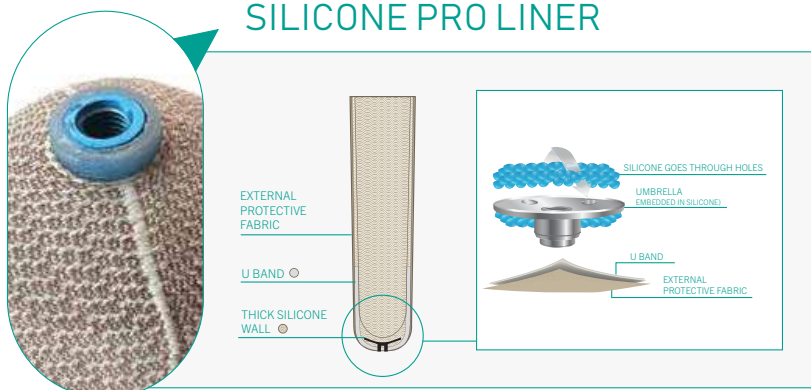

✓ Low-Profile Umbrella

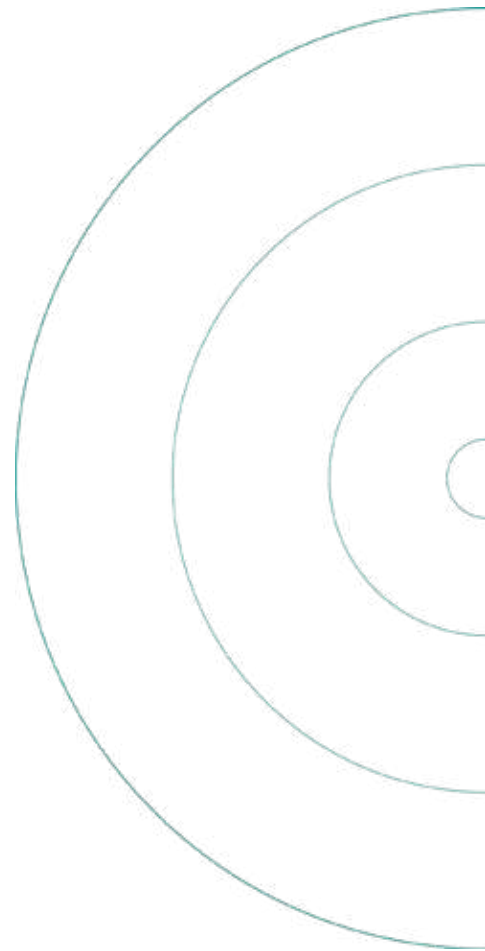







# LINER TECHNOLOGY

With a combination of five elastomers, five fabrics, and five suspension options, ALPS offers one of the most comprehensive and high-performing liner portfolios in the industry.

Each material is engineered to meet specific clinical and functional needs—from accommodating sensitive skin and residual limb volume changes to supporting high-activity users. This versatility enables prosthetists to select the ideal liner configuration for each patient, ensuring a precise fit, consistent comfort, and reliable suspension across a broad range of activity levels and limb conditions.

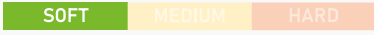



## 5 ELASTOMERS.

We offer five elastomers that function as interfaces between the residual limb and the socket, each designed with unique features to suit various patient needs.

Elastomer Name	Durometer Scale	Antioxidant Count
EasyGel		
GripGel		
HD Gel		N.A.
OptiGel		N.A.
OptiSil (Silicone)		N.A.





## 5 FABRICS.

Our fabric types are indicated by their unique characteristics and functions, offering users specific benefits based on their lifestyles and clinical conditions.

Fabric Type	Elongation (Stretch) Level
Beige	
Brown	
Seamless Knit	
Black	
Gray	

## 5 SUSPENSIONS.

We provide a range of suspension options to accommodate individual levels.

Suspension Type	Name or Associated Product (P)	Image	Description
Locking (1)	Reinforced Matrix		Characterized by low vertical and horizontal elongation
Locking (2)	U-Band		Characterized by low vertical elongation
Suction	Cushion		All cushion liners used with sleeves
Elevated Vacuum	<sup>P</sup> Vacuum Integrated Pump (VIP®)		Air expulsion integrated pump used with sleeves or UltraSeal
Hypobaric	<sup>P</sup> UltraSeal Liner		Features a sealing ring around the outer portion of the liner

### Hypobaric Suspension



# HOW ANTIOXIDANTS WORK

**ALPS EasyLiner® contains an antioxidant that is an effective scavenger of free radicals and hydroxyl groups.**

Beneficial effects to the skin of patients have been reported. These stories have been provided here as anecdotal evidence of the benefits that some patients have reported.

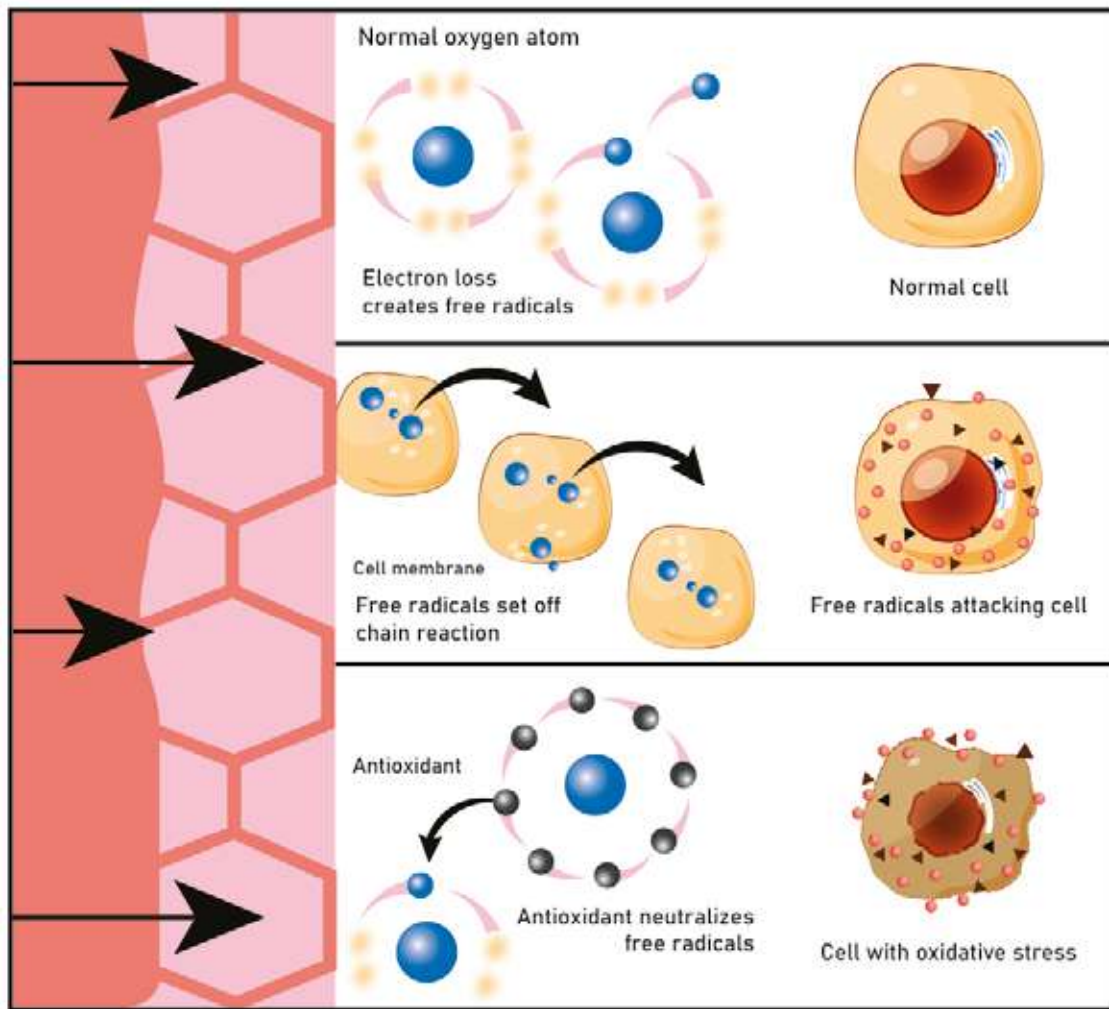



## DIABETIC AMPUTEE

Case history provided by: Jim McElhiney, CPO, Nashville (USA).

This patient is a severe diabetic, insulin dependent with compromised vascularization. A local hospital called Jim McElhiney, CPO in Nashville (USA), to evaluate this patient.

The first two pictures have been taken prior to the fitting by Jim McElhiney. The patient had been out of her prosthesis for 3 weeks and was being treated with wet and dry dressing. She was then fitted with ALPS EasyLiner® (Cushion Liner) and ALPS Easysleeve (Sealing Sleeve), creating a suction suspension system.



Before the fitting with ALPS EasyLiner®.



One week post initial fitting with ALPS EasyLiner®.



Three weeks post initial fitting with ALPS EasyLiner®.

## CASE STUDY 2

# PATIENT WITH DERMATITIS

Case history provided by: Wayne Sadler, CPO, Kentucky (USA).

This patient has been diagnosed with Contact Dermatitis. He followed the simple cleaning procedures as recommended by the manufacturer.

When that wasn't enough, he started using our product, these are the results.



Prior to fitting  
with ALPS EasyLiner®.



One week post fitting  
with ALPS EasyLiner®.

# A DIFFICULT RESIDUAL LIMB

Case history provided by: Palgi Orthopaedic, Israel.



Before, when wearing  
a silicone liner.



After, when fitted with  
ALPS EasyLiner® during 4 weeks.

# PROSTHETIC LINERS

A prosthetic liner serves to cover and protect the residual limb like a second skin and plays a key role in the suspension system of the prosthesis, increasing comfort and minimizing the risk of skin irritations. ALPS complete range of prosthetic liners is designed to focus on the needs of the individual to offer all users the best possible solution based on their specific needs.





# SoftSil Liner

Patent No. 11,602,445

ALPS SoftSil Liner delivers the same medical-grade qualities as our popular Silicone Pro but with enhanced features. Made with OptiSil, our new, soft, white silicone, and gray knitted fabric, the liner effectively offers a high degree of control and excellent freedom of movement without sacrificing a comfortable suspension in the user's prostheses.



## Material



OptiSil

## Fabric



Grey Fabric

## Activity level



K1



K2 ✓



K3 ✓



K4 ✓

## Thickness



2 mm

## Key Benefits



Medical grade, white silicone with 1/5 the friction of regular silicone offers superior comfort



Increased reduction of vertical stretch provides users with greater control and freedom of movement



Reduced pistoning



Skin friendly



Thin, lightweight & cooling

# SoftSil Liner SSGSL/SSGSC. Sizing chart.

Measure the circumference of the stump at 6 cm above the distal end.

Measured size (cm)	Locking 2mm uniform	Cushion 2mm uniform
20-22 cm	SSGSL-20	SSGSC-20
22-24 cm	SSGSL-22	SSGSC-22
24-26 cm	SSGSL-24	SSGSC-24
26-28 cm	SSGSL-26	SSGSC-26
28-30 cm	SSGSL-28	SSGSC-28
30-32 cm	SSGSL-30	SSGSC-30
32-35 cm	SSGSL-32	SSGSC-32
35-38 cm	SSGSL-35	SSGSC-35
38-41 cm	SSGSL-38	SSGSC-38
41-44 cm	SSGSL-41	SSGSC-41
44-47 cm	SSGSL-44	SSGSC-44

## Cross section



**SSGSC**  
Cushion

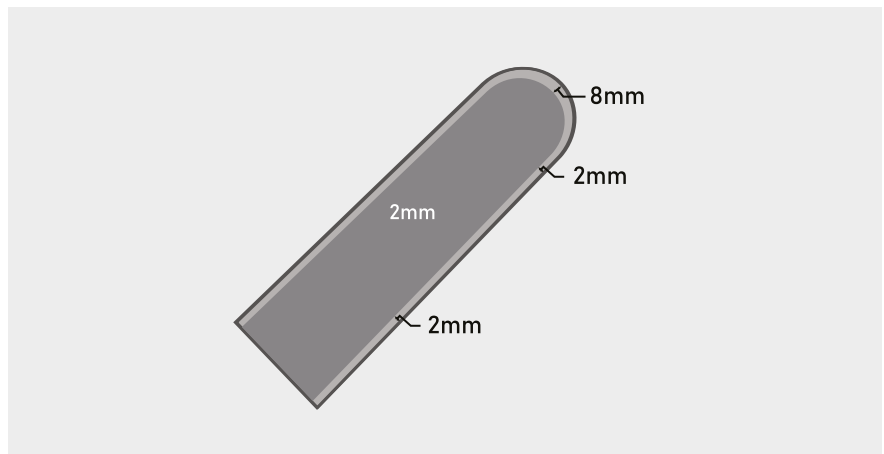

**SSGSL**  
Locking

**U-SHAPED REINFORCEMENT**

Wider distal ends that are proportionate to the size of the liner

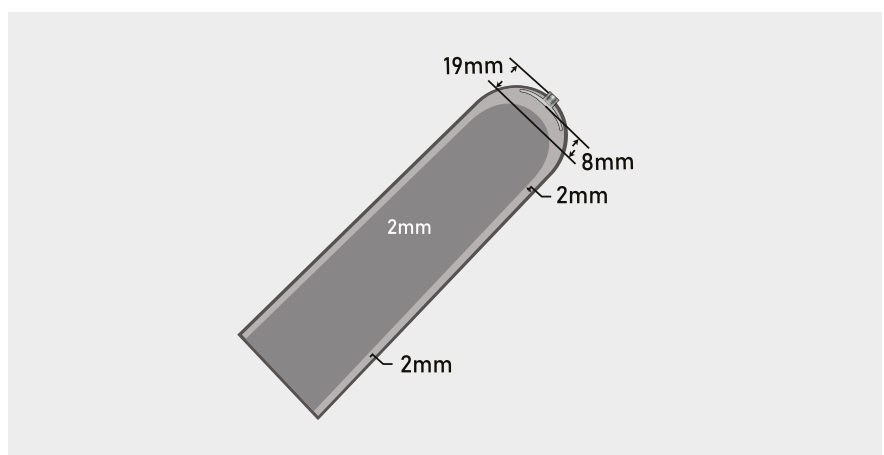

ALPS® Liner Technology

5 Elastomers. 5 Fabrics. 5 Suspensions.



# Pro-Fit Liner

ALPS Pro-Fit is a prosthetic liner made with OptiGel that ensures excellent conformability to the residual limb. At the same time, its new and improved distal end encapsulation allows the user to experience a highly secure fit, resulting in enhanced control, comfort, and safety.



## Material



OptiGel

## Fabric



Grey Fabric

## Activity level



K1



K2 ✓



K3 ✓



K4 ✓

## Thickness



3 mm

6 mm

## Key Benefits



New encapsulation allows the liner to fit better on the residual limb



Improves the control of the prosthetic leg and reduces pistoning while still providing superior protection of the residual limb



The superior adhesion of the OptiGel allows the safe suspension of the prosthetic leg



# Pro-Fit Liner PFGDT/PFGFR. Sizing chart.

Measure the circumference of the stump at 6 cm above the distal end.

Measured size (cm)	Locking 3mm or 6mm uniform	Cushion 3mm or 6mm uniform
16-19 cm	PFGDT16-( 3 or 6)	PFGFR16-( 3 or 6)
20-23 cm	PFGDT20-( 3 or 6)	PFGFR20-( 3 or 6)
24-25 cm	PFGDT24-( 3 or 6)	PFGFR24-( 3 or 6)
26-27 cm	PFGDT26-( 3 or 6)	PFGFR26-( 3 or 6)
28-31 cm	PFGDT28-( 3 or 6)	PFGFR28-( 3 or 6)
32-34 cm	PFGDT32-( 3 or 6)	PFGFR32-( 3 or 6)
35-37 cm	PFGDT35-( 3 or 6)	PFGFR35-( 3 or 6)
38-43 cm	PFGDT38-( 3 or 6)	PFGFR38-( 3 or 6)
44-53 cm	PFGDT44-( 3 or 6)	PFGFR44-( 3 or 6)

## Cross section



**PFGFR**  
Cushion

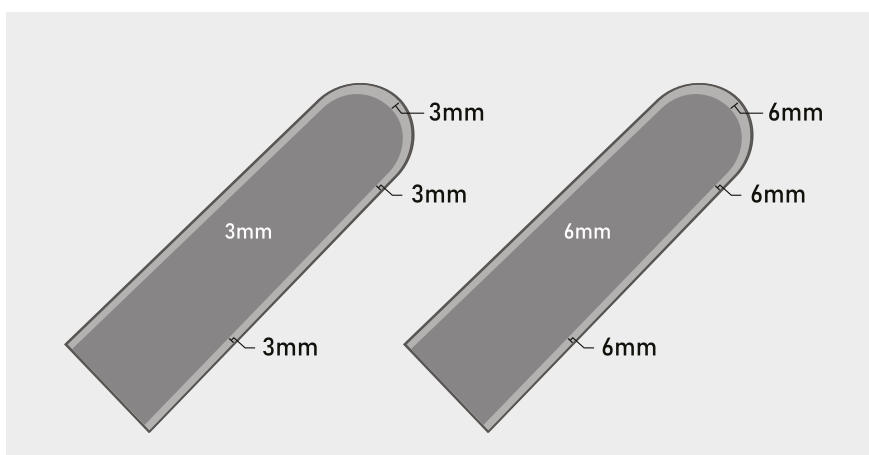

**PFGDT**  
Locking

**U-SHAPED REINFORCEMENT**

Wider distal ends that are proportionate to the size of the liner

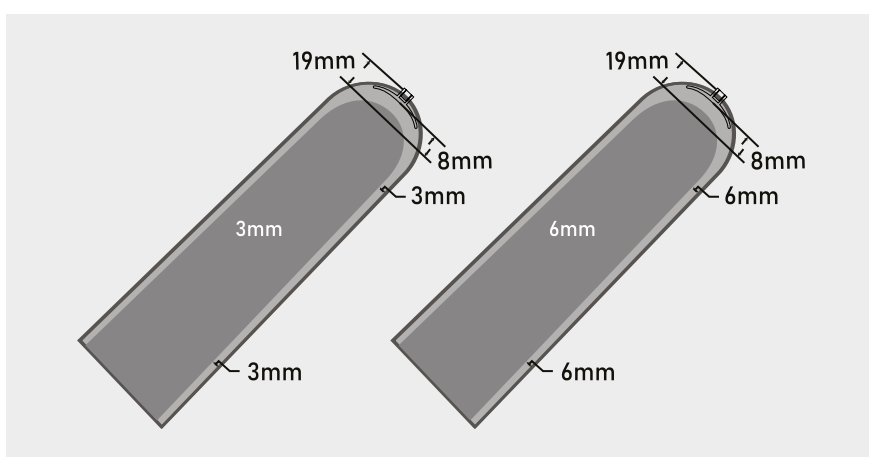

ALPS® Liner Technology

5 Elastomers. 5 Fabrics. 5 Suspensions.



# UltraSeal Silicone Liner

The ALPS® UltraSeal Liner features an integrated band that creates an airtight seal as the user steps into the socket. The liner's smooth inner wall, constructed with OptiSil, a new soft, white silicone, easily conforms to and cushions the residual limb. The silicone, combined with a strongly knitted fabric covering, creates excellent durability and a secure fit.



## Material



OptiSil

## Fabric



Grey Fabric

## Activity level



K1 ✓



K2 ✓



K3 ✓



K4 ✓

## Thickness



2 mm

## Key Benefits



Provides a comfortable cushion between the socket and residual limb and optimizes suspension while offering ultimate user convenience for daily use.



Outer knitted fabric combines strength and durability while allowing differentiated stretch and comfortable elasticity.



One sealing ring to ensure a secure hold. Available at three different heights: Ultra Low, Low, and High.



Medical-grade white silicone that contains 1/5 the friction of regular silicone.



Skin friendly, lightweight, and cooling.

# UltraSeal Silicone Liner USHSL/USHSC/USLSL/USLSC/USUSL/USUSC. Sizing Chart.

Measure the circumference of the residual limb at 6 cm above the distal end.

Measured size (cm)	High Ring Locking 2mm uniform	High Ring Cushion 2mm uniform	Low Ring Locking 2mm uniform	Low Ring Cushion 2mm uniform	Ultra Low Ring Locking 2mm uniform	Ultra Low Ring Cushion 2mm uniform
20-21 cm	USHSL20	USHSC20	USLSL20	USLSC20	USUSL20	USUSC20
22-23 cm	USHSL22	USHSC22	USLSL22	USLSC22	USUSL22	USUSC22
24-25 cm	USHSL24	USHSC24	USLSL24	USLSC24	USUSL24	USUSC24
26-27 cm	USHSL26	USHSC26	USLSL26	USLSC26	USUSL26	USUSC26
28-29 cm	USHSL28	USHSC28	USLSL28	USLSC28	USUSL28	USUSC28
30-31 cm	USHSL30	USHSC30	USLSL30	USLSC30	USUSL30	USUSC30
32-34 cm	USHSL32	USHSC32	USLSL32	USLSC32	USUSL32	USUSC32
35-37 cm	USHSL35	USHSC35	USLSL35	USLSC35	USUSL35	USUSC35
38-40 cm	USHSL38	USHSC38	USLSL38	USLSC38	USUSL38	USUSC38
41-43 cm	USHSL41	USHSC41	USLSL41	USLSC41	USUSL41	USUSC41
44-47 cm	USHSL44	USHSC44	USLSL44	USLSC44	USUSL44	USUSC44

USHSL/USHSC: Ring begins 18cm from the center of the distal end.

USLSL/USLSC: Ring begins 13cm from the center of the distal end.

USUSL/USUSC: Ring begins 8cm from the center of the distal end.

## Cross section



**USHSC  
USLSC  
USUSC**  
**Hypobaric**

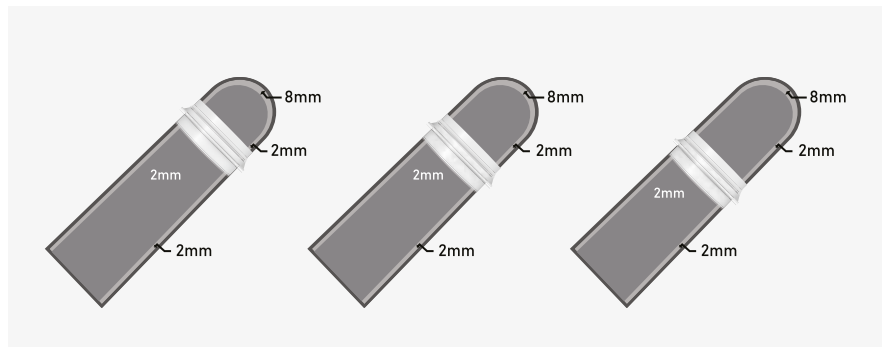

**USHSL  
USLSL  
USUSL**  
**Locking**

**U-SHAPED  
REINFORCEMENT**

Wider distal ends that are proportionate to the size of the liner

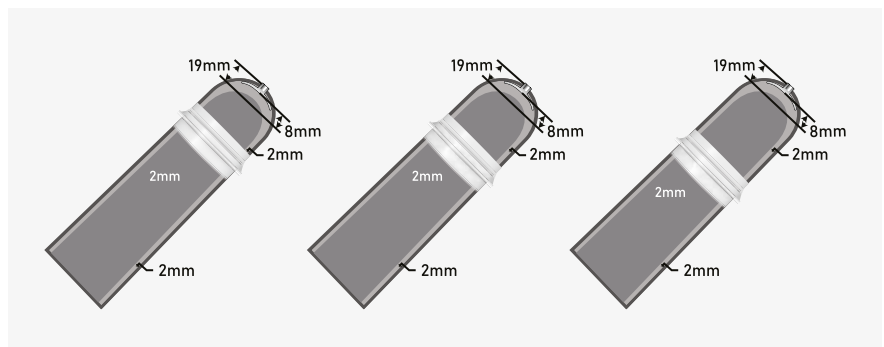

**ALPS® Liner Technology**

5 Elastomers. 5 Fabrics. 5 Suspensions.



# UltraSeal Gel Liner

Introducing the revolutionary UltraSeal gel liner—a groundbreaking product that seamlessly integrates advanced sealing technology with the superior benefits of gel.

With an integrated band available in three different heights, users will experience an airtight seal upon socket entry. When combined with OptiGel, this liner offers exceptional comfort and excellent conformity to the residual limb, ensuring a secure and snug fit that enhances control, comfort, and safety.



## Material



OptiGel

## Fabric



Grey Fabric

## Activity level



K1 ✓



K2 ✓



K3 ✓



K4 ✓

## Thickness



3 mm

## Key Benefits



OptiGel has a smooth, soft texture that ensures gentle skin contact and a tailored fit around the residual limb.



Outer knitted fabric combines strength and durability while allowing differentiated stretch and comfortable elasticity.



One sealing ring to ensure a secure hold. Available at three different heights: Ultra Low, Low, and High.



The locking feature ensures users are provided with a suspension that is secure, firm, and comfortable.

# UltraSeal Gel Liner USHGL/USHGC/USLGL/USLGC/USUGL/USUGC. Sizing Chart.

Measure the circumference of the residual limb at 6 cm above the distal end.

Measured size (cm)	High Ring Locking 3mm uniform	High Ring Cushion 3mm uniform	Low Ring Locking 3mm uniform	Low Ring Cushion 3mm uniform	Ultra Low Ring Locking 3mm uniform	Ultra Low Ring Cushion 3mm uniform
20-23 cm	USHGL20-3	USHGC20-3	USLGL20-3	USLGC20-3	USUGL20-3	USUGC20-3
24-25 cm	USHGL24-3	USHGC24-3	USLGL24-3	USLGC24-3	USUGL24-3	USUGC24-3
26-27 cm	USHGL26-3	USHGC26-3	USLGL26-3	USLGC26-3	USUGL26-3	USUGC26-3
28-31 cm	USHGL28-3	USHGC28-3	USLGL28-3	USLGC28-3	USUGL28-3	USUGC28-3
32-34 cm	USHGL32-3	USHGC32-3	USLGL32-3	USLGC32-3	USUGL32-3	USUGC32-3
35-37 cm	USHGL35-3	USHGC35-3	USLGL35-3	USLGC35-3	USUGL35-3	USUGC35-3
38-43 cm	USHGL38-3	USHGC38-3	USLGL38-3	USLGC38-3	USUGL38-3	USUGC38-3
44-47 cm	USHGL44-3	USHGC44-3	USLGL44-3	USLGC44-3	USUGL44-3	USUGC44-3

**USHGL/USHGC:** Ring begins 18cm from the center of the distal end.

**USLGL/USLGC:** Ring begins 13cm from the center of the distal end.

**USUGL/USUGC:** Ring begins 8cm from the center of the distal end.

## Cross section



**USHGC  
USLGC  
USUGC**

**Hypobaric**

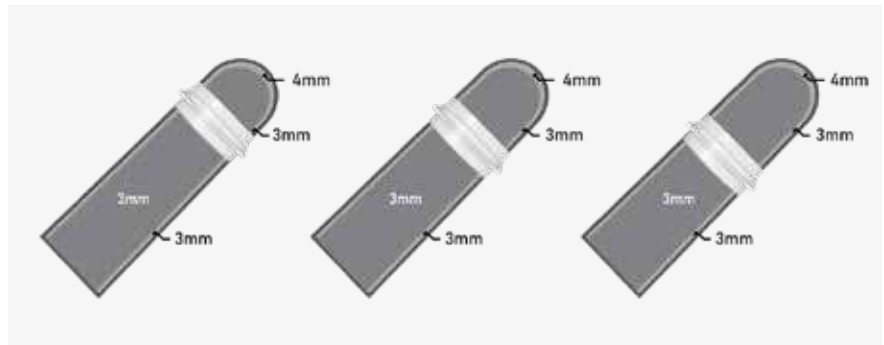

**USHGL  
USLGL  
USUGL**

**Locking**

**U-SHAPED  
REINFORCEMENT**

Wider distal ends that are proportionate to the size of the liner

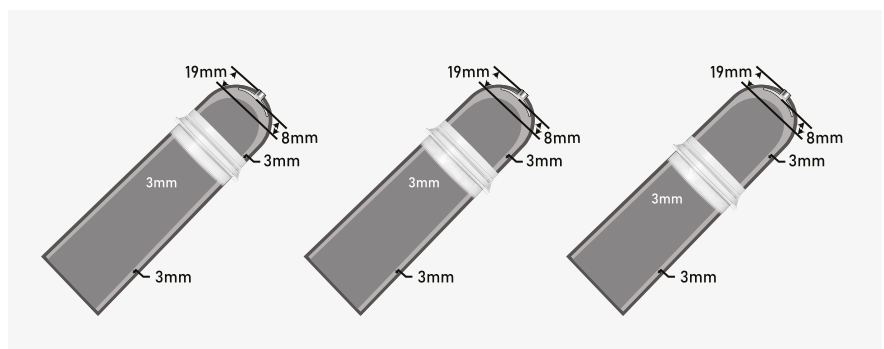

**ALPS® Liner Technology**

5 Elastomers. 5 Fabrics. 5 Suspensions.



# EasyLiner®

Patent No. 6,454,812\* | 7,709,570 | 7,709,570

ALPS EasyLiner® contains a prolonged-released antioxidant, an effective scavenger of free radicals and hydroxyl groups, with beneficial effects on the skin.

It provides the softness, strength, and cushioning from its use of ALPS EasyGel, relieving the residual limb from the stress created by vertical and shear forces. It delicately conforms to the shape of the residual limb without restricting blood flow. It can be easily donned even by geriatric patients and users with reduced manual dexterity.



## Material



EasyGel

## Fabric



Beige Fabric

## Activity level



K1 ✓



K2 ✓



K3 ✓



K4 ✓

## Thickness



3 mm



6 mm



3/6 mm

## Key Benefits



Indicated for delicate skin and diabetic patients thanks to the antioxidants contained in the gel



Protects the residual limb thanks to the high capacity of the EasyGel to absorb vertical and shear forces



Further relieves the skin from stress generated by shear forces thanks to its low coefficient of static friction



Delicately conforms to the shape of the residual limb and does not restrict blood flow



Easy to don also for patients with reduced manual dexterity

# EasyLiner® ELDT/ELFR. Sizing chart.

Measure the circumference of the stump at 6 cm above the distal end.

Measured size (cm)	Locking 3mm, 6mm, 6/3mm or 9mm*	Cushion 3mm, 6mm, 6/3mm or 9mm*
10-15 cm	N.A.	ELFR10-(3 or 6)
16-19 cm	ELDT16-(3, 6, or 6/3)	ELFR16-(3, 6, or 6/3)
20-23 cm	ELDT20-(3, 6, or 6/3)	ELFR20-(3, 6, or 6/3)
24-25 cm	ELDT24-(3, 6, 6/3, or 9)	ELFR24-(3, 6, 6/3, or 9)
26-27 cm	ELDT26-(3, 6, or 6/3)	ELFR26-(3, 6, or 6/3)
28-31 cm	ELDT28-(3, 6, 6/3, or 9)	ELFR28-(3, 6, 6/3, or 9)
32-34 cm	ELDT32-(3, 6, or 6/3)	ELFR32-(3, 6, or 6/3)
35-37 cm	ELDT35-(3 or 6)	ELFR35-(3 or 6)
38-43 cm	ELDT38-(3, 6, or 6/3)	ELFR38-(3, 6, or 6/3)
44-53 cm	ELDT44-(3, 6, or 6/3)	ELFR44-(3, 6, or 6/3)

\*9mm only available in sizes 24 and 28; size 35 available only in 3mm and 6mm.

## Cross section



**ELFR**  
Cushion

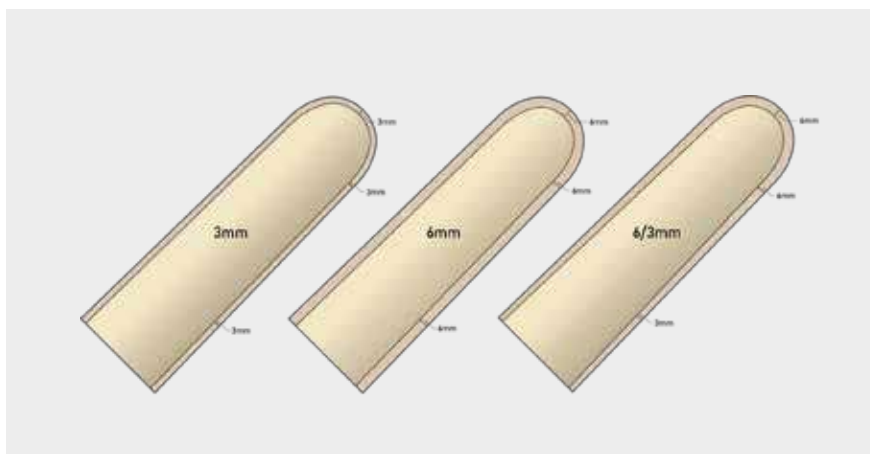

**ELDT**  
Locking  
REINFORCED MATRIX

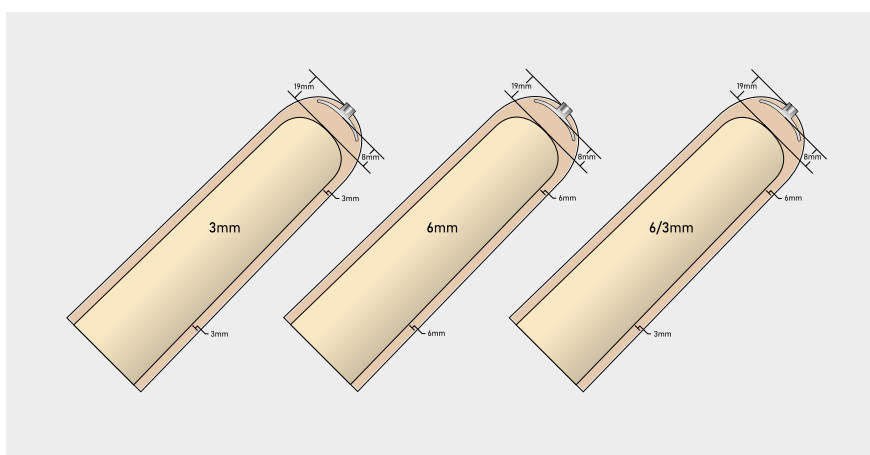

ALPS® Liner Technology

5 Elastomers. 5 Fabrics. 5 Suspensions.



# Silicone Pro Liner

Patent No. 5,507,834\* | 6,454,812\*

The Silicone Pro liner is manufactured with medical grade hypoallergenic silicone. The surface of the silicone features a low coefficient of static friction (1/5 of regular silicone). Without any additives, it is a hypoallergenic liner, very delicate on the skin. The liner is extremely lightweight and promotes the skin's natural thermoregulation.

The locking version features an innovative U matrix to limit vertical stretch while not constraining the residual limb.



## Material



Silicone

## Fabric



Seamless  
Knitted Fabric

## Activity level



K1 ✓



K2 ✓



K3 ✓



K4 ✓

## Thickness



2 mm

## Key Benefits



Does not constrict the residual limb and minimizes the pistoning effect thanks to the innovative U matrix (locking version)



Great freedom of movement thanks to the 2mm posterior thickness



Indicated for delicate skin since it is made of medical grade hypoallergenic silicone



Minimizes friction to the residual limb due to its low coefficient of friction



Helps the thermoregulation of the residual limb



Easy to clean



# Silicone Pro Liner LSC/LSL. Sizing chart.

Measure the circumference of the stump at 6 cm above the distal end.

Measured size (cm)	Locking 2.0 mm uniform	Cushion 2.0 mm uniform
20-22 cm	LSL3.0-20	LSC3.0-20
22-24 cm	LSL3.0-22	LSC3.0-22
24-26 cm	LSL3.0-24	LSC3.0-24
26-28 cm	LSL3.0-26	LSC3.0-26
28-30 cm	LSL3.0-28	LSC3.0-28
30-32 cm	LSL3.0-30	LSC3.0-30
32-35 cm	LSL3.0-32	LSC3.0-32
35-38 cm	LSL3.0-35	LSC3.0-35
38-41 cm	LSL3.0-38	LSC3.0-38
41-44 cm	LSL3.0-41	LSC3.0-41
44-47 cm	LSL3.0-44	LSC3.0-44

## Cross section



**LSC**  
Cushion

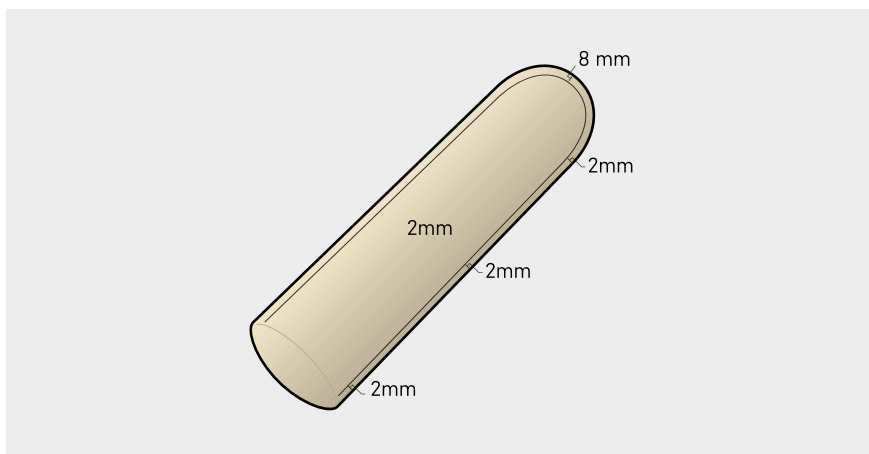

**LSL**  
Locking  
U-SHAPED  
REINFORCEMENT

Wider distal ends that are proportionate to the size of the liner

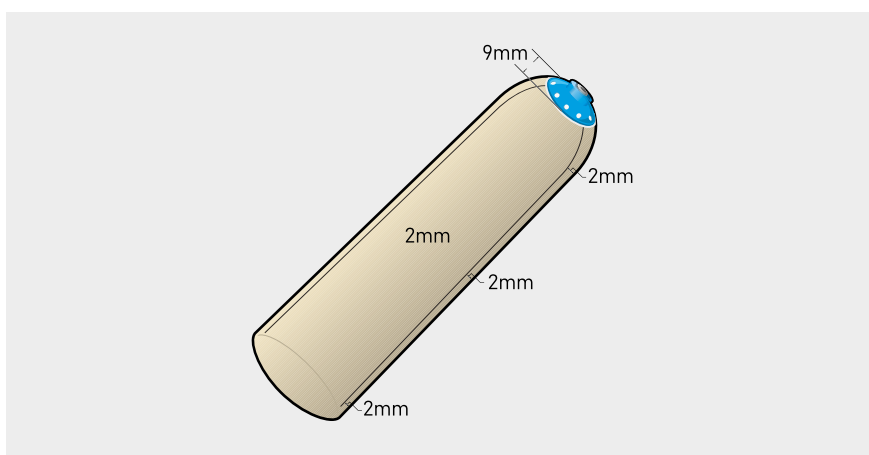

ALPS® Liner Technology

5 Elastomers. 5 Fabrics. 5 Suspensions.



# Superior Performance Liner

Patent No. 6,454,812\*

ALPS Superior Performance prosthetic liner combines a limited vertical stretch fabric with our GripGel.

GripGel, with its softness, strength, and cushioning provides the greatest possible protection to the residual limb. The fabric, with its limited vertical elongation, improves control and stability of the prosthetic leg by reducing pistoning. The result is a comfortable liner, indicated for patients with low and medium activity levels.



## Material



GripGel

## Fabric



Black Fabric

## Activity level



K1 ✓



K2 ✓



K3 ✓



K4

## Thickness



3 mm



6 mm

## Key Benefits



Protects the residual limb thanks to the high capacity of the GripGel to absorb vertical and shear forces



Improves control of the prosthetic leg thanks to the limited vertical stretch of the fabric



Reduces pistoning thanks to the fabric's limited vertical stretch and the distal matrix (locking version)



Safe suspension of the prosthetic leg thanks to the high level of adhesion of the GripGel

# Superior Performance Liner SPDT/SPFR. Sizing chart.

Measure the circumference of the stump at 6 cm above the distal end.

Measured size (cm)	Locking 3mm or 6mm uniform	Cushion 3mm or 6mm uniform
16-19 cm	SPDT16-( 3 or 6)	SPFR16-( 3 or 6)
20-23 cm	SPDT20-( 3 or 6)	SPFR20-( 3 or 6)
24-25 cm	SPDT24-( 3 or 6)	SPFR24-( 3 or 6)
26-27 cm	SPDT26-( 3 or 6)	SPFR26-( 3 or 6)
28-31 cm	SPDT28-( 3 or 6)	SPFR28-( 3 or 6)
32-34 cm	SPDT32-( 3 or 6)	SPFR32-( 3 or 6)
35-37 cm	SPDT35-( 3 or 6)	SPFR35-( 3 or 6)
38-43 cm	SPDT38-( 3 or 6)	SPFR38-( 3 or 6)
44-53 cm	SPDT44-( 3 or 6)	SPFR44-( 3 or 6)

## Cross section



**SPFR**  
Cushion

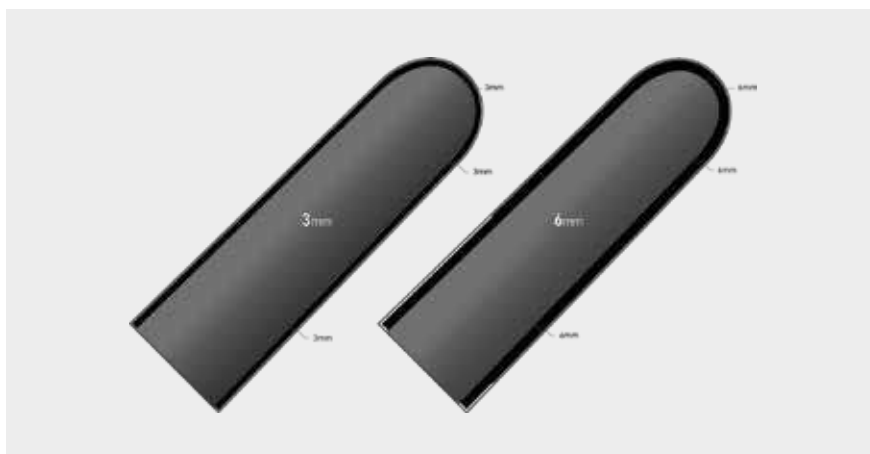

**SPDT**  
Locking

**REINFORCED MATRIX**  
Wider distal ends that are proportionate to the size of the liner

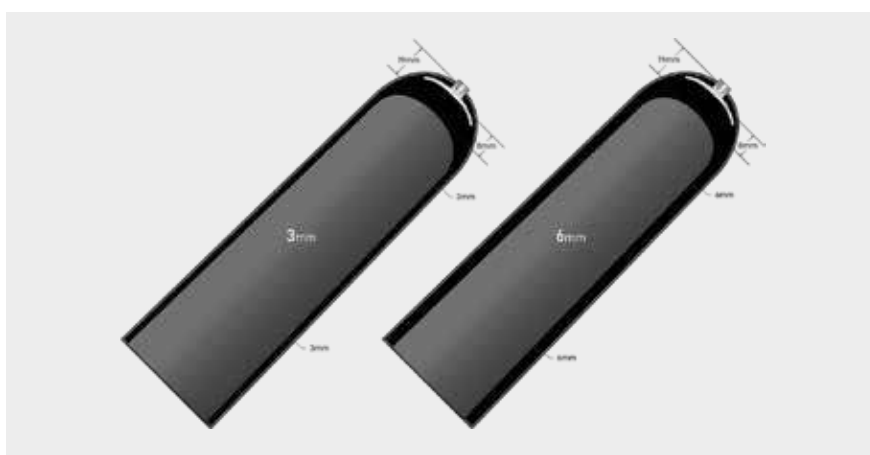

ALPS® Liner Technology

5 Elastomers. 5 Fabrics. 5 Suspensions.



# Superior Performance HD Liner

Patent No. 6,454,812\*

ALPS Superior Performance prosthetic liner, in its HD Gel version, provides the patient with comfort and control.

The HD Gel provides relief to the residual limb from vertical and shear forces; at the same time, it makes the liner more compact. The fabric, with its limited vertical elongation, further limits the vertical pistoning.



## Material



High Density Gel

## Fabric



Black Fabric

## Activity level



K1



K2 ✓



K3 ✓



K4 ✓

## Thickness



3 mm

6 mm

## Key Benefits



Reduces pistoning thanks to the fabric's limited vertical stretch and the distal matrix (locking version)



Minimizes the movement of soft tissue and provides a high level of control of the prosthetic leg by combining the properties of the High Density Gel with those of the limited vertical stretch fabric



Protects the residual limb thanks to the high capacity of the HD Gel to absorb vertical and shear forces

# Superior Performance Liner SPDTHD/SPFRHD. Sizing chart.

Measure the circumference of the stump at 6 cm above the distal end.

Measured size (cm)	Locking 3mm or 6mm uniform	Cushion 3mm or 6mm uniform
16-19 cm	SPDTHD16-( 3 or 6)	SPFRHD16-( 3 or 6)
20-23 cm	SPDTHD20-( 3 or 6)	SPFRHD20-( 3 or 6)
24-25 cm	SPDTHD24-( 3 or 6)	SPFRHD24-( 3 or 6)
26-27 cm	SPDTHD26-( 3 or 6)	SPFRHD26-( 3 or 6)
28-31 cm	SPDTHD28-( 3 or 6)	SPFRHD28-( 3 or 6)
32-34 cm	SPDTHD32-( 3 or 6)	SPFRHD32-( 3 or 6)
35-37 cm	SPDTHD35-( 3 or 6)	SPFRHD35-( 3 or 6)
38-43 cm	SPDTHD38-( 3 or 6)	SPFRHD38-( 3 or 6)
44-53 cm	SPDTHD44-( 3 or 6)	SPFRHD44-( 3 or 6)

## Cross section



**SPFRHD**  
Cushion

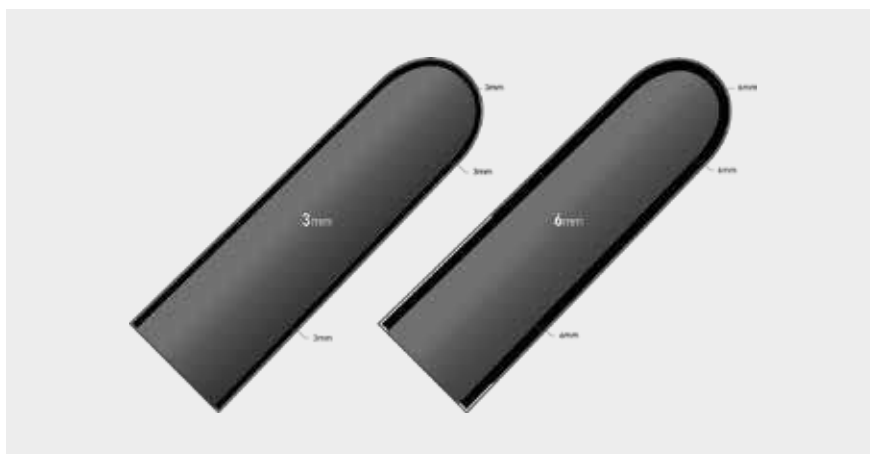

**SPDTHD**  
Locking

**REINFORCED MATRIX**  
Wider distal ends that are proportionate to the size of the liner

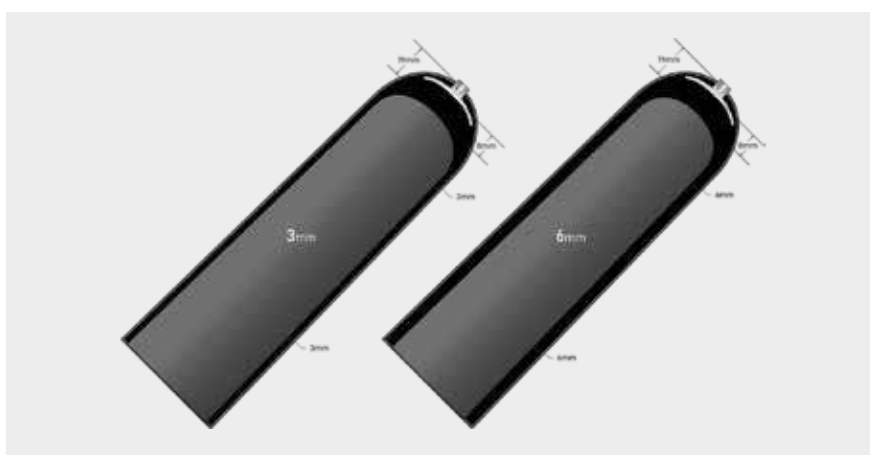

ALPS® Liner Technology

5 Elastomers. 5 Fabrics. 5 Suspensions.



# General Purpose Liner

Patent No. 6,454,812\*

The General Purpose liner contains the softness, strength, and cushioning of our GripGel, relieving the residual limb from the stress generated by vertical and shear forces. The superior elongation of this prosthetic liner means that blood flow is not restricted and it allows the liner to delicately conform to the shape of the residual limb. It is easily donned even by geriatric patients or those with reduced manual dexterity.



## Material



GripGel

## Fabric



Beige Fabric

## Activity level



K1 ✓



K2 ✓



K3 ✓



K4 ✓

## Thickness



3 mm



6 mm

## Key Benefits



Delicately conforms to the shape of the residual limb and does not restrict blood flow



Easy to don also for patients with reduced manual dexterity



Protects the residual limb thanks to the high capacity of the GripGel to absorb vertical and shear forces



Safe suspension of the prosthesis due to the superior adhesive properties of the GripGel

# General Purpose Liner GPDT/GPFR. Sizing chart.

Measure the circumference of the stump at 6 cm above the distal end.

Measured size (cm)	Locking 3mm or 6mm uniform	Cushion 3mm or 6mm uniform
16-19 cm	GPDT16-(3 or 6)	GPFR16-(3 or 6)
20-23 cm	GPDT20-(3 or 6)	GPFR20-(3 or 6)
24-25 cm	GPDT24-(3 or 6)	GPFR24-(3 or 6)
26-27 cm	GPDT26-(3 or 6)	GPRF26-(3 or 6)
28-31 cm	GPDT28-(3 or 6)	GPRF28-(3 or 6)
32-34 cm	GPDT32-(3 or 6)	GPFR32-(3 or 6)
35-37 cm	GPDT35-(3 or 6)	GPFR35-(3 or 6)
38-43 cm	GPDT38-(3 or 6)	GPFR38-(3 or 6)
44-53 cm	GPDT44-(3 or 6)	GPFR44-(3 or 6)
44-70* cm	GPDT-XL*	N.A.

\*GPDT-XL comes in 3mm thickness only. It features a larger umbrella and a U-Shaped matrix. Ideal for bariatric patients.

## Cross section



**GPFR**  
Cushion

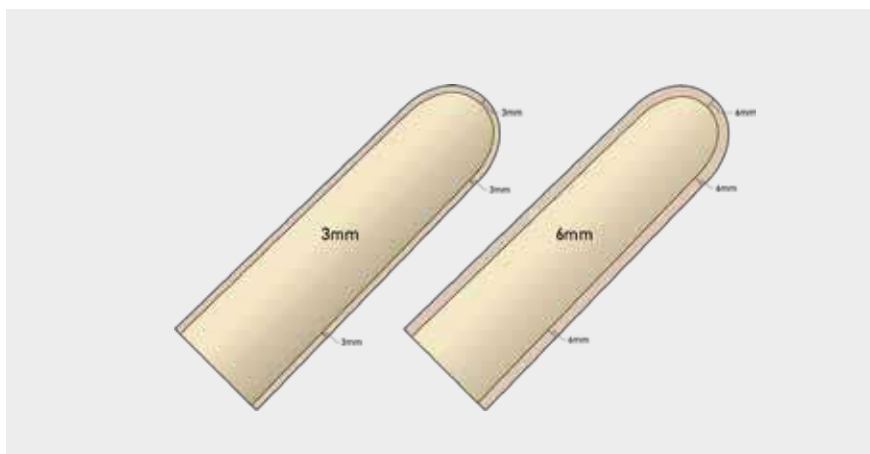

**GPDT**  
Locking  
REINFORCED MATRIX

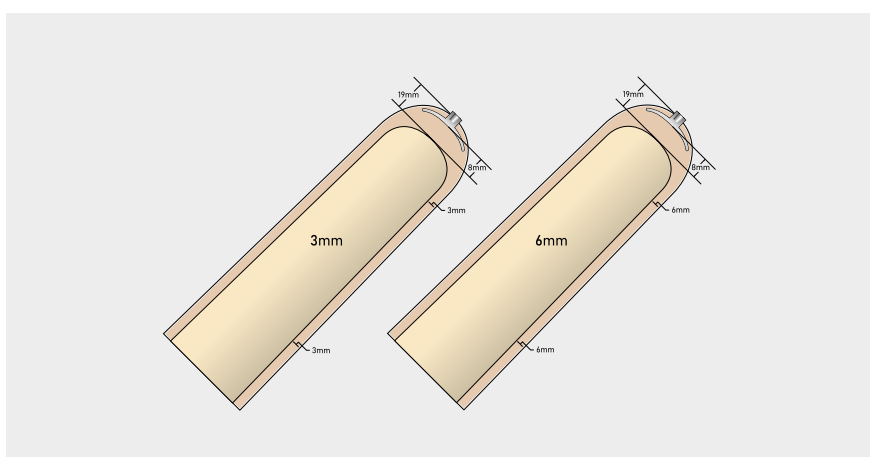

ALPS® Liner Technology

5 Elastomers. 5 Fabrics. 5 Suspensions.



# Eco™ Liner

Patent No. 6,454,812\* | 7,709,570 | 10,966,845 | 7,709,570

ALPS Eco™ Liner features an innovative knitted fabric with areas of varying elasticity to improve the control of the prosthetic leg. The HD Gel helps keep the residual limb more compact and provides enhanced stability to the prosthetic leg, at the same time ensuring a high level of protection from vertical and shear forces. The locking version features an innovative U matrix to limit the vertical stretch without constraining the residual limb.



## Material



High Density Gel

## Fabric



Seamless  
Knitted Fabric

## Activity level



K1 ✓



K2 ✓



K3 ✓



K4 ✓

## Thickness



3 mm



6 mm

## Key Benefits



Protects the residual limb thanks to the high capacity of the HD Gel to absorb vertical and shear forces



Ensures maximum control of the prosthetic leg and minimizes soft tissue movement thanks to the High Density Gel



Improved comfort due to the effect of the innovative seamless knitted fabric providing areas of varying levels of elasticity



Does not constrict the residual limb and minimizes the pistoning effect thanks to the innovative U matrix (locking version)



# Eco™ Liner ECDTHD/ECFRHD. Sizing chart.

Measure the circumference of the stump at 6 cm above the distal end.

Measured size (cm)	Locking 3mm or 6mm uniform	Cushion 3mm or 6mm uniform
20-23 cm	ECDTHD20-( 3 or 6)	ECFRHD20-( 3 or 6)
24-25 cm	ECDTHD24-( 3 or 6)	ECFRHD24-( 3 or 6)
26-27 cm	ECDTHD26-( 3 or 6)	ECFRHD26-( 3 or 6)
28-31 cm	ECDTHD28-( 3 or 6)	ECFRHD28-( 3 or 6)
32-34 cm	ECDTHD32-( 3 or 6)	ECFRHD32-( 3 or 6)
35-37 cm	ECDTHD35-( 3 or 6)	ECFRHD35-( 3 or 6)
38-43 cm	ECDTHD38-( 3 or 6)	ECFRHD38-( 3 or 6)
44-53 cm	ECDTHD44-( 3 or 6)	ECFRHD44-( 3 or 6)

## Cross section



**ECFRHD**  
Cushion

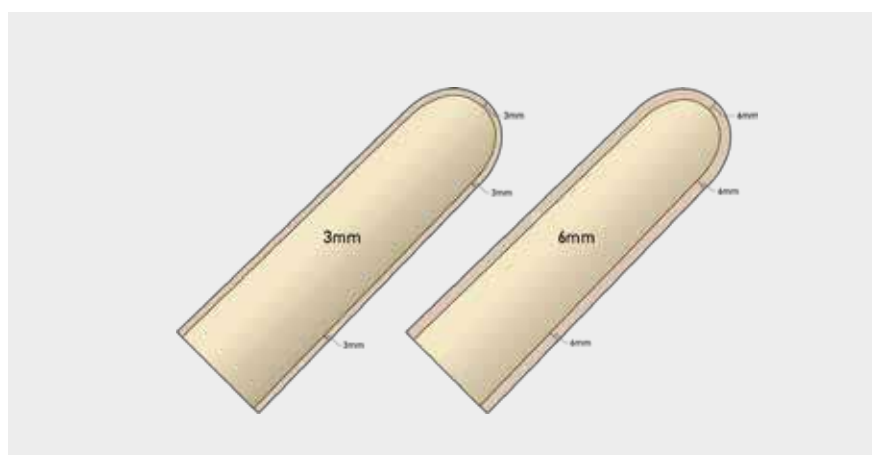

**ECDTHD**  
Locking

**U-SHAPED  
REINFORCEMENT**

Wider distal ends that are proportionate to the size of the liner

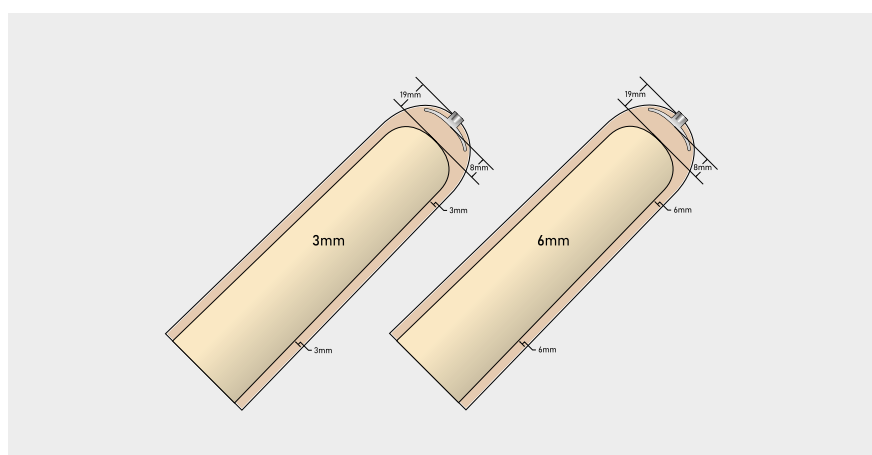

**ALPS® Liner Technology**

5 Elastomers. 5 Fabrics. 5 Suspensions.



# Smart Seal™ Liner

Patent No. 6,454,812\* | 8,852,291 | 9,216,099 | 11,179,252 | 8,852,291  
9,216,099 | 11,179,252

## For hypobaric suspension

ALPS Smart Seal liner features integrated, silicone coated sealing bands that create a safe interface. The bands stretch against the socket wall, preventing the liner from slipping. The inner HD Gel layer, thanks to its low modulus of elasticity, easily conforms to the residual limb without restricting the blood flow. It is available in two configurations with different sealing band heights.



### Material



High Density Gel

### Fabric



Seamless  
Knitted Fabric

### Activity level



K1 ✓



K2 ✓



K3 ✓



K4 ✓

### Thickness



3 mm    6 mm

## Key Benefits



Ensures a high level of control of the prosthetic leg and minimizes soft tissue movement thanks to the High Density Gel



Non-constrictive hypobaric suspension thanks to its integrated, silicone coated sealing bands



Indicated both for transtibial and transfemoral users since the sealing bands are available in two different configurations



Maximum stability of the liner within the socket due to the High Density Gel and the use of a limited vertical stretch fabric in the distal area

# Smart Seal™ Liner SAFR/SADT/SBFR. Sizing chart.

Measure the circumference of the stump at 6 cm above the distal end.

Measured size (cm)	SAFR - Cushion 3mm or 6mm uniform
26-27 cm	SAFR26-(3 or 6)
28-31 cm	SAFR28-(3 or 6)
32-34 cm	SAFR32-(3 or 6)
35-37 cm	SAFR35-(3 or 6)
38-43 cm	SAFR38-(3 or 6)

Measured size (cm)	SBFR - Cushion 3mm or 6mm uniform
20-23 cm	SBFR20-(3 or 6)
24-25 cm	SBFR24-(3 or 6)
26-27 cm	SBFR26-(3 or 6)
28-31 cm	SBFR28-(3 or 6)

Measured size (cm)	SADT - Locking 3mm or 6mm uniform
20-23 cm	SADT20-(3 or 6)
24-25 cm	SADT24-(3 or 6)
26-27 cm	SADT26-(3 or 6)
28-31 cm	SADT28-(3 or 6)
32-37 cm	SADT32-(3 or 6)
38-43 cm	SADT38-(3 or 6)

## SAFR

Rings begin 12.5 cm from the center of the distal end.

## SBFR

Rings begin 7.5 cm from the center of the distal end.

## SADT

Sizes 20-28: rings begin 7.5 cm from the center of the distal end.

Sizes 32-38: rings begin 12.7 cm from the center of the distal end.

## Cross section



### SAFR/SBFR Cushion

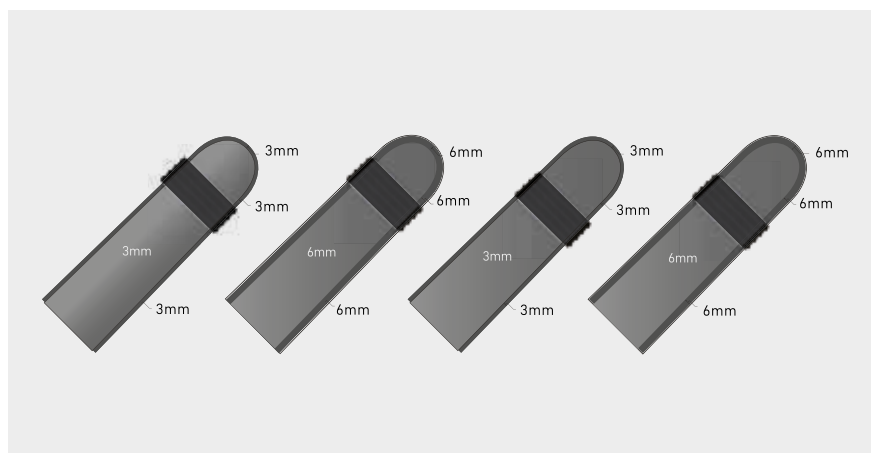

### SADT Locking

#### U-SHAPED REINFORCEMENT

Wider distal ends that are proportionate to the size of the liner

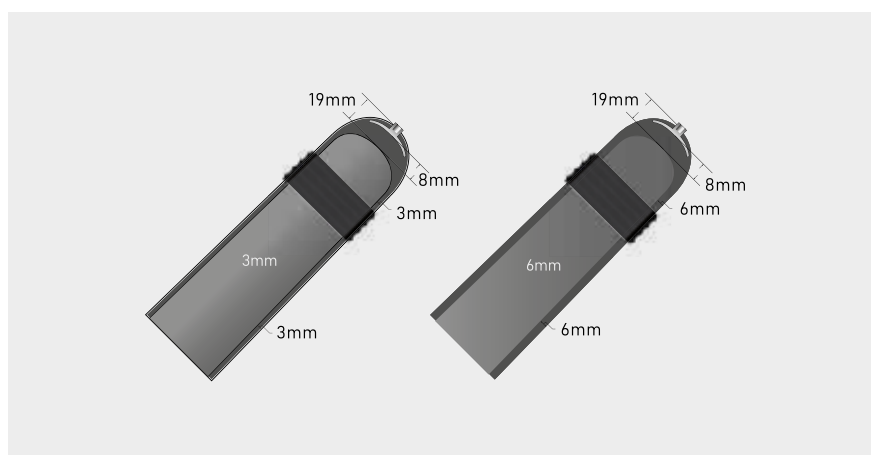

ALPS® Liner Technology

5 Elastomers. 5 Fabrics. 5 Suspensions.



# Extreme™ Liner

Patent No. 6,454,812\*

The ALPS Extreme prosthetic liner combines softness, strength, and cushioning from our GripGel with a fabric with limited vertical stretch. It improves the control of the prosthetic leg and reduces pistoning, while still providing superior protection of the residual limb. The superior adhesion of the GripGel allows the safe suspension of the prosthetic leg. The result is a comfortable and versatile liner, indicated for patients with low and medium activity levels.



## Material



GripGel

## Fabric



Brown Fabric

## Activity level



K1 ✓



K2 ✓



K3 ✓



K4

## Thickness



3 mm 6 mm

## Key Benefits



Protects the residual limb thanks to the high capacity of the GripGel to absorb vertical and shear forces



Improves control of the prosthetic leg thanks to the limited vertical stretch of the fabric



Reduces pistoning thanks to the fabric's limited vertical stretch and the distal matrix (locking version)



Safe suspension of the prosthesis due to the superior adhesive properties of the GripGel

# Extreme™ Liner AKDT/AKFR. Sizing chart.

Measure the circumference of the stump at 6 cm above the distal end.

Measured size (cm)	Locking 3mm or 6mm uniform	Cushion 3mm or 6mm uniform
16-19 cm	AKDT16-( 3 or 6)	AKFR16-( 3 or 6)
20-23 cm	AKDT20-( 3 or 6)	AKFR20-( 3 or 6)
24-25 cm	AKDT24-( 3 or 6)	AKFR24-( 3 or 6)
26-27 cm	AKDT26-( 3 or 6)	AKFR26-( 3 or 6)
28-31 cm	AKDT28-( 3 or 6)	AKFR28-( 3 or 6)
32-34 cm	AKDT32-( 3 or 6)	AKFR32-( 3 or 6)
35-37 cm	AKDT35-( 3 or 6)	AKFR35-( 3 or 6)
38-43 cm	AKDT38-( 3 or 6)	AKFR38-( 3 or 6)
44-53 cm	AKDT44-( 3 or 6)	AKFR44-( 3 or 6)

## Cross section



**AKFR**  
Cushion

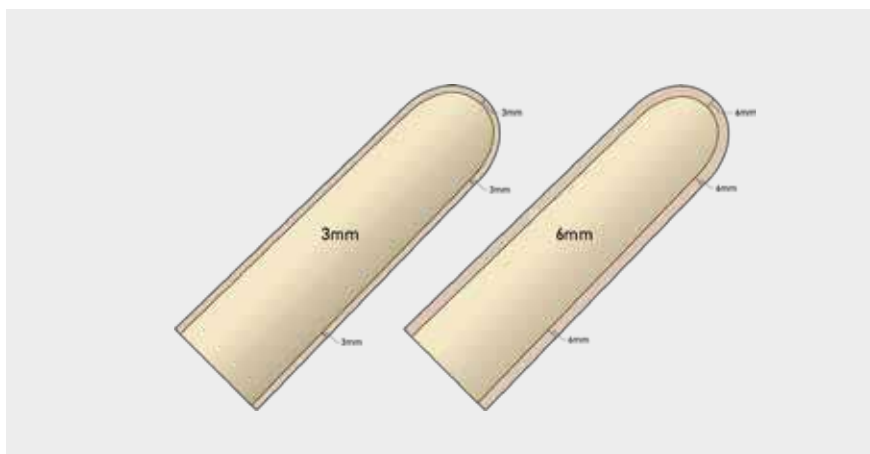

**AKDT**  
Locking

**REINFORCED MATRIX**  
Wider distal ends that are proportionate to the size of the liner

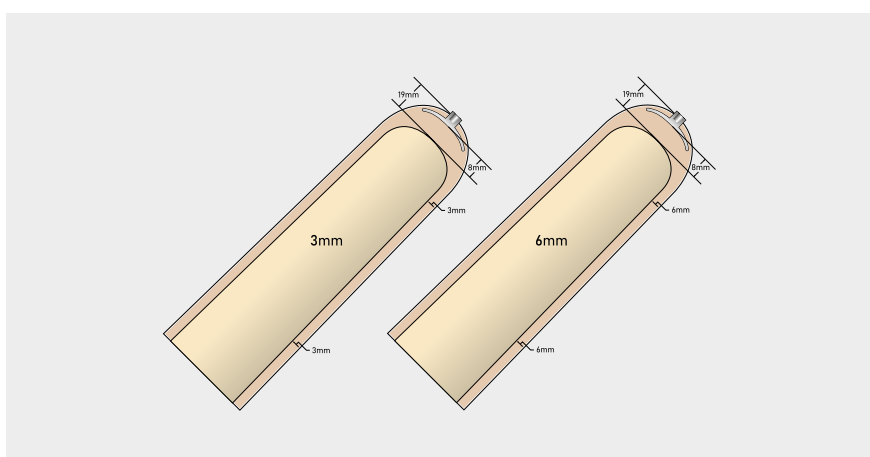

ALPS® Liner Technology

5 Elastomers. 5 Fabrics. 5 Suspensions.



# Extreme™ HD Liner

Patent No. 6,454,812\*

ALPS Extreme™ prosthetic liner, in its HD Gel version, provides the patient with comfort and control. The HD Gel relieves the residual limb from vertical and shear forces; at the same time, it makes the liner more compact. The fabric, with its limited vertical elongation, further limits vertical pistoning. This makes it an ideal liner for the most active users who are looking to maintain maximum control of the prosthetic leg without compromising comfort.



## Material



High Density Gel

## Fabric



Brown Fabric

## Activity level



K1



K2 ✓



K3 ✓



K4 ✓

## Thickness



3 mm

6 mm

## Key Benefits



Reduces pistoning thanks to the fabric's limited vertical stretch and the distal matrix (locking version)



Minimizes the movement of soft tissue and provides a high level of control of the prosthetic leg by combining the properties of the High Density Gel with those of the limited vertical stretch fabric



Protects the residual limb thanks to the high capacity of the HD Gel to absorb vertical and shear forces

# Extreme™ Liner AKDTHD/AKFRHD. Sizing chart.

Measure the circumference of the stump at 6 cm above the distal end.

Measured size (cm)	Locking 3mm or 6mm uniform	Cushion 3mm or 6mm uniform
16-19 cm	AKDTHD16-( 3 or 6)	AKFRHD16-( 3 or 6)
20-23 cm	AKDTHD20-( 3 or 6)	AKFRHD20-( 3 or 6)
24-25 cm	AKDTHD24-( 3 or 6)	AKFRHD24-( 3 or 6)
26-27 cm	AKDTHD26-( 3 or 6)	AKFRHD26-( 3 or 6)
28-31 cm	AKDTHD28-( 3 or 6)	AKFRHD28-( 3 or 6)
32-34 cm	AKDTHD32-( 3 or 6)	AKFRHD32-( 3 or 6)
35-37 cm	AKDTHD35-( 3 or 6)	AKFRHD35-( 3 or 6)
38-43 cm	AKDTHD38-( 3 or 6)	AKFRHD38-( 3 or 6)
44-53 cm	AKDTHD44-( 3 or 6)	AKFRHD44-( 3 or 6)

## Cross section



**AKFRHD**  
Cushion

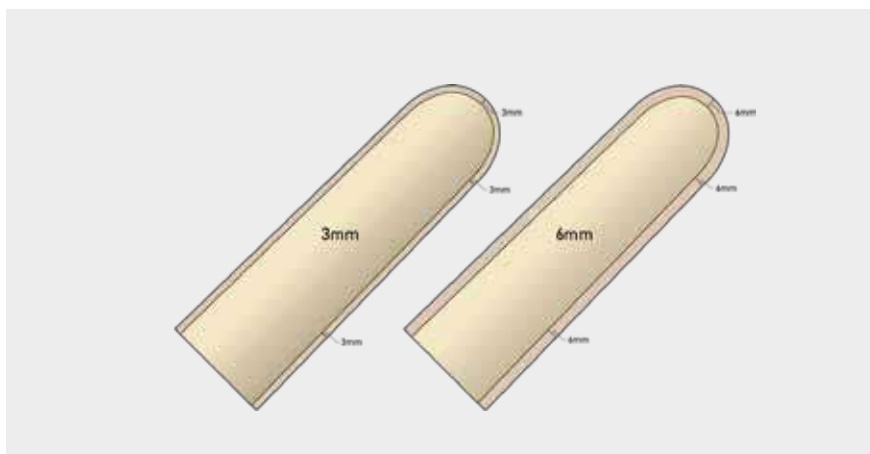

**AKDTHD**  
Locking

**REINFORCED MATRIX**  
Wider distal ends that are proportionate to the size of the liner

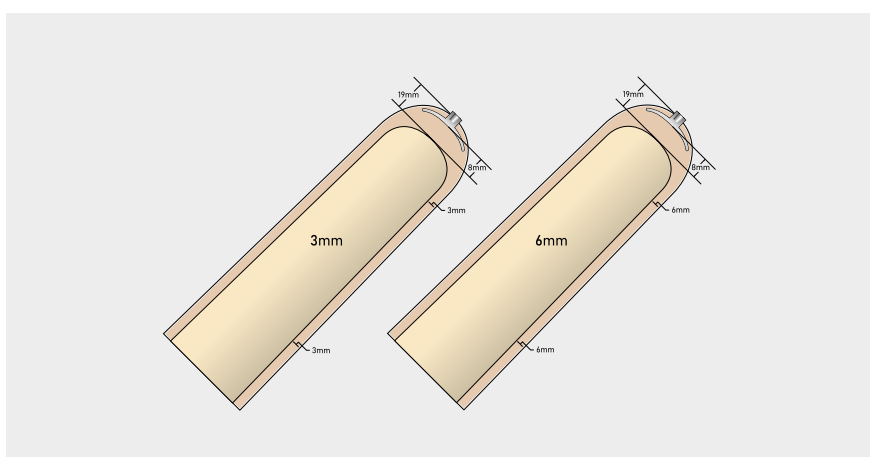

ALPS® Liner Technology

5 Elastomers. 5 Fabrics. 5 Suspensions.



# EasyFlex™ Liner

Patent No. 6,454,812\* | 7,709,570 | 8,226,732 | 8,246,694 | 8,349,021

ALPS EasyFlex™ prosthetic liner allows users ease of knee flexion thanks to an unlimited restriction of stretch anteriorly. Posteriorly the fabric, with its limited vertical stretch, improves the control of the prosthetic leg. The prolonged-released antioxidant contained in the EasyGel is an effective scavenger of free radicals and hydroxyl groups, providing beneficial effects on the skin. The EasyFlex™ Liner is designed for use with a pin and lock suspension system.



## Material



EasyGel

## Fabric



Beige  
Fabric



Brown  
Fabric

## Activity level



K1 ✓



K2 ✓



K3 ✓



K4 ✓

## Thickness



3 mm



6 mm

## Key Benefits



Indicated for delicate skin and diabetic patients thanks to the antioxidants contained in the gel



Protects the residual limb thanks to the high capacity of the EasyGel to absorb vertical and shear forces



Further relieves the skin from stress generated by shear forces thanks to its low coefficient of static friction



Allows an easy knee flexion and improves the control of the prosthetic leg, since it has been engineered using two types of fabric with different elasticity



Supplied with distal attachment for pin and lock suspension systems



# EasyFlex™ Liner EZF. Sizing chart.

Measure the circumference of the stump at 6 cm above the distal end.

Measured size (cm)	Locking 3mm or 6mm uniform
16-19 cm	EZF16-(3 or 6)
20-23 cm	EZF20-(3 or 6)
24-25 cm	EZF24-(3 or 6)
26-27 cm	EZF26-(3 or 6)
28-31 cm	EZF28-(3 or 6)
32-34 cm	EZF32-(3 or 6)
35-37 cm	EZF35-(3 or 6)
38-43 cm	EZF38-(3 or 6)
44-53 cm	EZF44-(3 or 6)

## Cross section



**EZF**  
**Locking**

**REINFORCED MATRIX**

Wider distal ends that are proportionate to the size of the liner

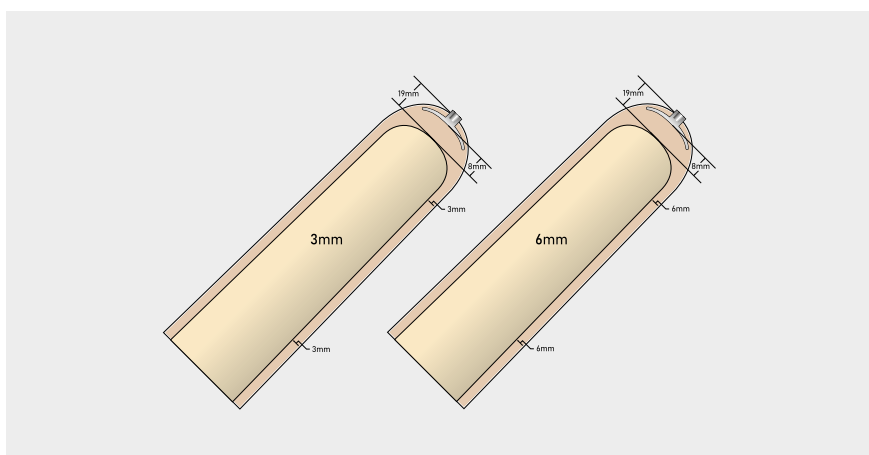

# EasyLiner® SuperStretch

Patent No.7,709,570

ALPS EasyLiner® SuperStretch is a soft, robust and versatile prosthetic liner made of EasyGel without the restriction of a fabric cover.

It allows complete freedom of movement and conforms to irregularly shaped residual limbs without restricting blood flow. Due to the low coefficient of friction of the EasyGel, it relieves the skin from the stress created by shear forces. The prolonged-released antioxidant has beneficial effects on the skin.



## Material



EasyGel

## Activity level



K1 ✓



K2 ✓



K3



K4

## Thickness



6 mm

## Key Benefits



Indicated for delicate skin and diabetic patients thanks to the antioxidants contained in the gel



Protects the residual limb thanks to the high capacity of the EasyGel to absorb vertical and shear forces



Further relieves the skin from stress generated by shear forces thanks to its low coefficient of static friction



Made of EasyGel with no fabric cover, it allows a superior fit to irregular shapes without constricting the residual limb

# EasyLiner® SuperStretch ELPX. Sizing chart.

Measure the circumference of the stump at 6 cm above the distal end.

Measured size (cm)	Cushion 6mm uniform
10-15 cm	ELPX-10
16-19 cm	ELPX-16
20-23 cm	ELPX-20
24-25 cm	ELPX-24
26-27 cm	ELPX-26
28-31 cm	ELPX-28
32-37 cm	ELPX-32
38-43 cm	ELPX-38

## Cross section



**ELPX**  
**Cushion**

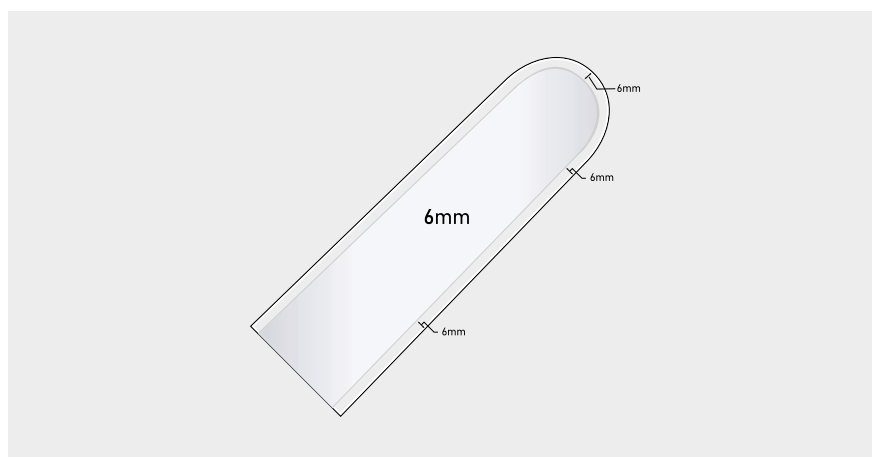

**ALPS® Liner Technology**

5 Elastomers. 5 Fabrics. 5 Suspensions.



# Anterior Posterior Tapered Liner

Patent No. 6,454,812\* | 8,226,732 | 8,246,694 | 8,349,021 | 8,226,732

ALPS AP Tapered Liner is gradually tapered from the thicker anterior to the thinner posterior side to provide freedom of movement to transtibial users.

The 6 mm frontal wall ensures a high level of protection to bony areas. By combining a high density gel with a limited vertical stretch fabric, this liner minimizes soft tissue movement and reduces vertical pistoning, offering a high level of control of the prosthetic leg.



## Material



High Density Gel

## Fabric



Black Fabric

## Activity level



K1 ✓

K2 ✓

K3 ✓

K4 ✓

## Thickness



6/3mm AP Tapered

## Key Benefits



Reduces pistoning thanks to the fabric's limited vertical stretch and the distal matrix (locking version)



Protects the residual limb thanks to the high capacity of the HD Gel to absorb vertical and shear forces



Protects bony areas with its 6 mm anterior wall thickness



Great freedom of movement thanks to the 3 mm posterior thickness



Minimizes soft tissue movement and provides superior control of the prosthetic leg by combining High Density Gel with a limited vertical stretch fabric

# Anterior Posterior Tapered Liner APDT/APFR. Sizing chart.

Measure the circumference of the stump at 6 cm above the distal end.

Measured size (cm)	Locking 6/3mm tapered	Cushion 6/3mm tapered
20-23 cm	APDT20-TP	APFR20-TP
24-25 cm	APDT24-TP	APFR24-TP
26-27 cm	APDT26-TP	APFR26-TP
28-31 cm	APDT28-TP	APFR28-TP
32-37 cm	APDT32-TP	APFR32-TP

## Cross section



**APFR**  
Cushion

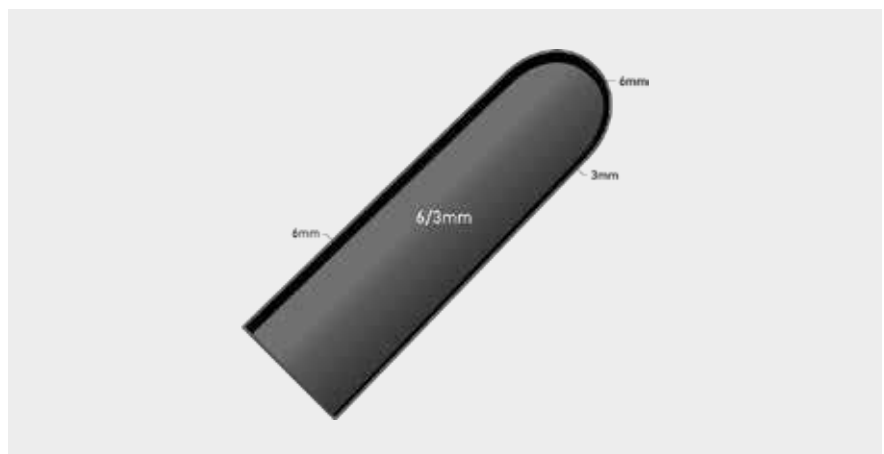

**APDT**  
Locking

**REINFORCED MATRIX**  
Wider distal ends that are proportionate to the size of the liner



**ALPS® Liner Technology**

5 Elastomers. 5 Fabrics. 5 Suspensions.



# PSI Liner

Patent No.7,709,570 | 8,357,206 | 8,394,150

The PSI Liner improves suspension by sealing onto the sleeves of a transtibial prosthesis. The EasyGel provides comfort and durability, relieving the skin from the stress created by vertical and shear forces. The antioxidant contained in the gel has beneficial effects on the skin.

The PSI Liner can be used in conjunction with current valve suction or vacuum systems being used on the market today.



## Material



EasyGel

## Fabric



Black Fabric

## Activity level



K1 ✓



K2 ✓



K3



K4

## Thickness



6 mm

6/3 mm

## Key Benefits



Indicated for delicate skin and diabetic patients thanks to the antioxidants contained in the gel



Protects the residual limb thanks to the high capacity of the EasyGel to absorb vertical and shear forces



Further relieves the skin from stress generated by shear forces thanks to its low coefficient of static friction



The proximal area with no fabric cover seals onto the sleeve to create a secure suspension

# Proximal Seal Interface Liner PSI. Sizing chart.

Measure the circumference of the stump at 6 cm above the distal end.

Measured size (cm)	Cushion 6mm or 3/6mm tapered
16-19 cm	PSI16-(6 or 6/3)
20-23 cm	PSI20-(6 or 6/3)
24-25 cm	PSI24-(6 or 6/3)
26-27 cm	PSI26-(6 or 6/3)
28-31 cm	PSI28-(6 or 6/3)
32-37 cm	PSI32-(6 or 6/3)
38-43 cm	PSI38-(6 or 6/3)
44-53 cm	PSI44-(6 or 6/3)

## Cross section



**PSI**  
**Cushion**

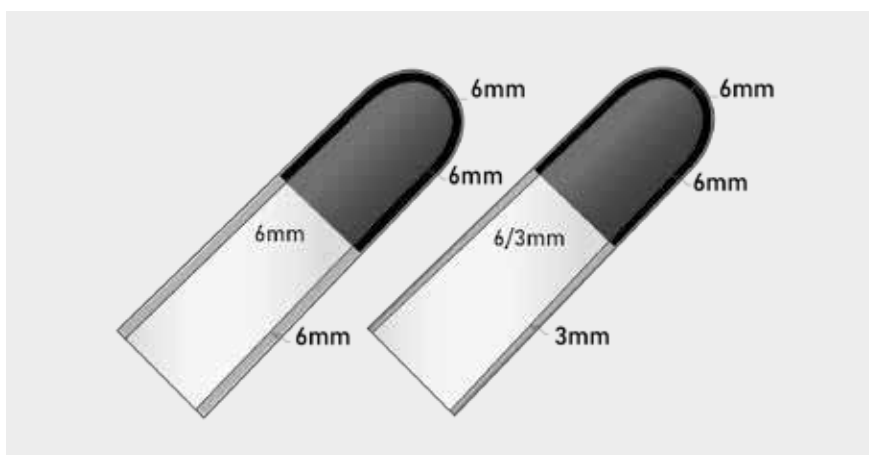

# Liberty™ Liner

Patent No. 6,544,292\* | 6,454,812\* | 6,361,568\* | 8,382,852 | 8,808,394

The Liberty™ Liner allows the expulsion of air and humidity through a built-in valve integrated either on the pin or the reducer, promoting a healthy environment. Used in conjunction with a nylon sheath, it presents a superior capacity for collecting and expelling humidity. The HD gel improves the stability of the prosthetic leg and provides greater protection against vertical and shear forces. It is recommended to minimize the problem of excessive perspiration.



## Material



High Density Gel

## Fabric



Seamless  
Knitted Fabric

## Activity level



K1 ✓



K2 ✓



K3 ✓



K4 ✓

## Thickness



3 mm 6 mm

## Key Benefits



Protects the residual limb thanks to the high capacity of the HD Gel to absorb vertical and shear forces



Promotes a healthy environment due to the distal valve that expels air and humidity between the residual limb and the liner



Ensures a high level of control of the prosthetic leg and minimizes soft tissue movement thanks to the High Density Gel



Since it is used in conjunction with a nylon sheath, it has a superior capacity for collecting and expelling humidity



# Liberty™ Liner II VSDT. Sizing chart.

Measure the circumference of the stump at 6 cm above the distal end.

Measured size (cm)	Locking 3mm uniform	Locking 6mm uniform
20-23 cm	VSDT20-3	VSDT20-6
24-25 cm	VSDT24-3	VSDT24-6
26-27 cm	VSDT26-3	VSDT26-6
28-31 cm	VSDT28-3	VSDT28-6
32-37 cm	VSDT32-3	VSDT32-6
38-43 cm	VSDT38-3	VSDT38-6

## Cross section



### VSDT Locking

#### U-SHAPED REINFORCEMENT

Wider distal ends that are proportionate to the size of the liner

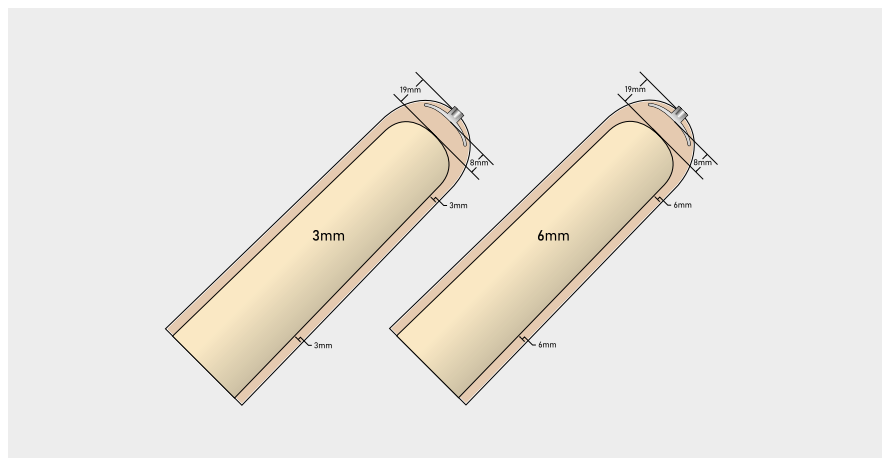

PRODUCT IMAGE	PART NAME	PART #
	LIBERTY LINER II REDUCER WITH BUILT-IN VALVE	LDA-764
	LIBERTY LINER II PIN WITH BUILT-IN VALVE Only compatible with ALPS locks	LDP-764
	LIBERTY LINER II PIN WITH BUILT-IN VALVE Compatible with most shuttle locks	LDPU-864

SOLD SEPARATELY — USE CODES BELOW WHEN ORDERING

LDA-764 - LIBERTY LINER II REDUCER WITH BUILT-IN VALVE

LDP-764 - LIBERTY LINER II PIN WITH BUILT-IN VALVE Only compatible with ALPS locks

LDPU-864 - LIBERTY LINER II PIN WITH BUILT-IN VALVE Compatible with most shuttle locks

ALPS® Liner Technology

5 Elastomers. 5 Fabrics. 5 Suspensions.



# PROSTHETIC SUSPENSION SYSTEMS

Sleeves

Locks

Elevated Vacuum





# Reinforced Flex Sleeve



ALPS Reinforced Flex Sleeve – a true game-changer in the world of high-performance prosthetic sleeves. Featuring a combination of either grey or black fabric with OptiGel and an extra layer of internal fabric, the RFX® delivers unparalleled durability, comfort, and control for even the most demanding users. Plus, with its 30° pre-flexion construct, users can say goodbye to bunching and discomfort behind the knee and hello to a new level of mobility and freedom

## Material



OptiGel

## Fabric



Grey or Black

## Activity level



K1



K2 ✓



K3 ✓



K4 ✓

## Thickness



3 mm

## Key Benefits



Extra layer of internal fabric provides a more durable option for high-activity users



Premium fabric combined with OptiGel delivers maximum comfort and high performance



30° pre-flexion to ease bending and reduce bunching behind the knee



Provides a secure suspension



OptiGel offers a great degree of control



Available in one length that accommodates most users

# Reinforced Flex Sleeve RFX. Sizing chart

Measure the circumference of the leg at 10 cm above the centre of the knee.

Measured size (cm)	3mm grey	3mm black
34-37 cm	RFX20-3G	RFX20-3BL
36-39 cm	RFX23-3G	RFX23-3BL
38-42 cm	RFX26-3G	RFX26-3BL
41-46 cm	RFX29-3G	RFX29-3BL
45-50 cm	RFX32-3G	RFX32-3BL

## Cross section

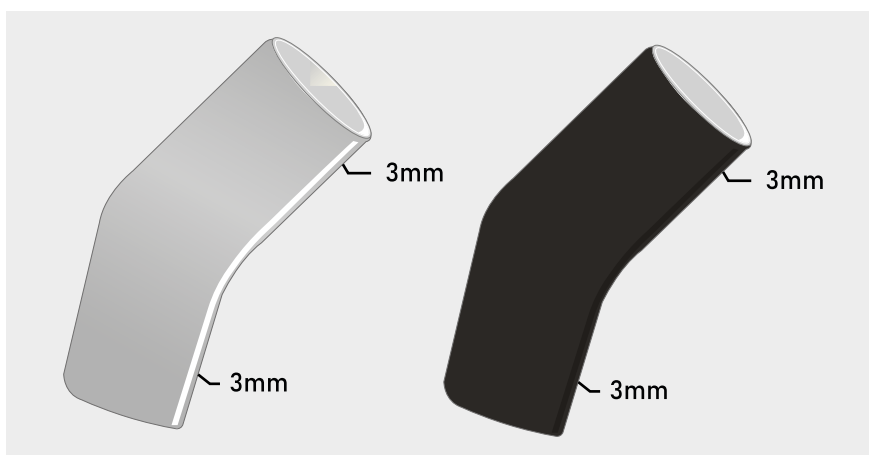

ALPS® Liner Technology

5 Elastomers. 5 Fabrics. 5 Suspensions.



# Reinforced Sleeve

ALPS Reinforced Sleeve is constructed with gray knitted fabric, OptiGel, and an extra layer of internal fabric to deliver superior durability. This combination works together to provide the maximum comfort, control, and high-performance capabilities required for higher activity-level users.



## Material



OptiGel

## Fabric



Grey Fabric

## Activity level



K1



K2 ✓



K3 ✓



K4 ✓

## Thickness



3 mm

## Key Benefits



Extra layer of internal fabric provides a more durable option for high-activity users



Gray knitted fabric's differential stretch attributes allow for maximum comfort and stability



Provides a secure suspension



OptiGel offers a great degree of control



The gel sticks to the patients skin without causing shear force and helps prevent the sleeve from rolling down the amputee's limb.

## Reinforced Sleeve RFS. Sizing chart

Measure the circumference of the leg at 10 cm above the centre of the knee.

Measured size (cm)	3mm uniform
25-30 cm	RFS20-3G
31-34 cm	RFS24-3G
35-37 cm	RFS26-3G
38-40 cm	RFS28-3G
41-45 cm	RFS32-3G
46-60 cm	RFS38-3G
61-70 cm	RFS44-3G

### Cross section

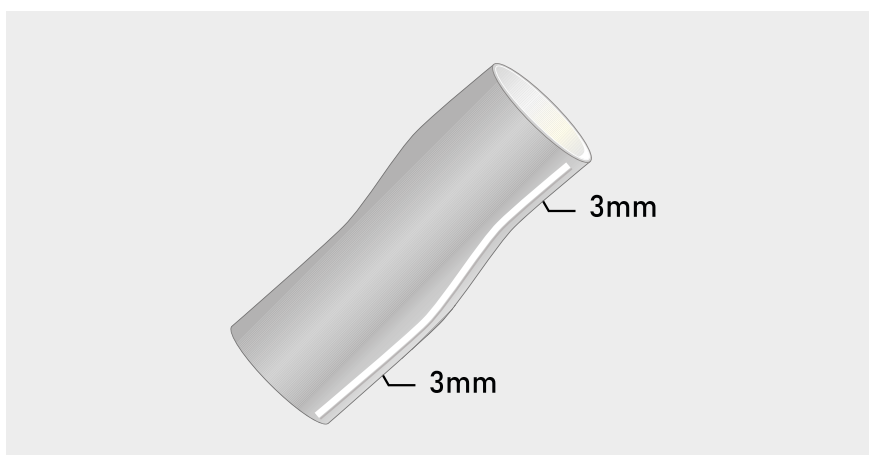

# EasySleeve

Patent No. 7,709,570

ALPS EasySleeve Reinforced Fabric prosthetic gel sleeve provides superior comfort thanks to its use of ALPS EasyGel. The elasticity of the fabric allows the user a great deal of freedom of knee flexion. The EasySleeve also achieves secure suspension by sealing to the skin without restricting circulation. The lower coefficient of friction found with the EasyGel helps relieve the skin of shear forces.



## Material



EasyGel

## Fabric



Beige  
Fabric

## Activity level



K1 ✓



K2 ✓



K3 ✓



K4 ✓

## Thickness



3 mm



6 mm

## Key Benefits



Easy to don also for patients with reduced manual dexterity



Indicated for delicate and fragile skins thanks to the antioxidants contained in the gel

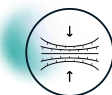

Minimizes compression and irritation proximally



Allows a high degree of freedom of knee flexion



Relieves the skin from stress generated by shear forces thanks to EasyGel's low coefficient of static friction



# EasySleeve SFR. Sizing chart

Measure the circumference of the leg at 10 cm above the centre of the knee.

Measured size (cm)	3mm or 6mm uniform
16-19 cm	SFR10-(3 or 6)
20-24 cm	SFR16-(3 or 6)
25-30 cm	SFR20-(3 or 6)
31-34 cm	SFR24-(3 or 6)
35-37 cm	SFR26-(3 or 6)
38-40 cm	SFR28-(3 or 6)
41-45 cm	SFR32-(3 or 6)
46-60 cm	SFR38-(3 or 6)
61-70 cm	SFR44-(3 or 6)

## Cross section

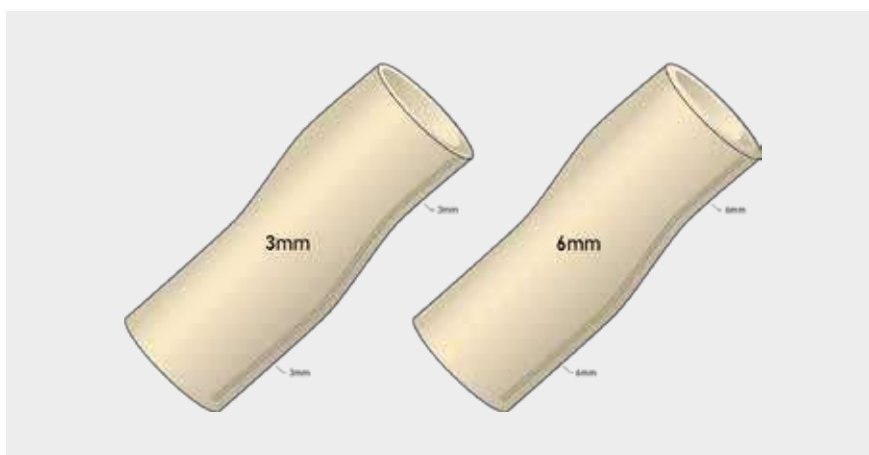

ALPS® Liner Technology

5 Elastomers. 5 Fabrics. 5 Suspensions.



# EasySleeve SuperStretch

Patent No. 7,709,570

ALPS EasySleeve SuperStretch is a prosthetic gel sleeve that allows freedom of knee flexion as well as providing secure suspension by sealing to the skin without restricting circulation.



## Material



EasyGel

## Activity level



K1 ✓



K2 ✓



K3



K4

## Thickness



6 mm

## Key Benefits



Indicated for delicate and fragile skins thanks to the antioxidants contained in the gel



Minimizes compression and irritation proximally



Allows a high degree of freedom of knee flexion



Relieves the skin from stress generated by shear forces thanks to EasyGel's low coefficient of static friction

# EasySleeve SuperStretch SLE. Sizing chart

Measure the circumference of the leg at 10 cm above the centre of the knee.

Measured size (cm)	6mm uniform
16-19 cm	SLE-10
20-24 cm	SLE-16
25-30 cm	SLE-20
31-34 cm	SLE-24
35-37 cm	SLE-26
38-40 cm	SLE-28
41-45 cm	SLE-32

## Cross section



ALPS® Liner Technology

5 Elastomers. 5 Fabrics. 5 Suspensions.



# Flex Sleeve

ALPS Flex Sleeve (SFX) prosthetic suspension sleeve combines a seamless knitted fabric with a High Density Gel to provide maximum comfort and high performance.

The SFX provides a 30° pre-flexion which eases bending and reduces bunching behind the knee. It is indicated for medium and high activity users.



## Material



High Density Gel

## Fabric



Seamless  
Knitted Fabric

## Activity level



K1 ✓



K2 ✓



K3 ✓



K4 ✓

## Thickness



3 mm

## Key benefits

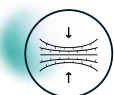

Minimizes compression and irritation proximally



Ease of knee flexion and reduced bunching in the popliteal



The High Density Gel ensures superior control even for more active users



Available in 3 mm thickness and two optional colors



Provides a secure suspension of the prosthetic leg



Recommended for waterproof prostheses

## Flex Sleeve SFX. Sizing chart

Measure the circumference of the leg at 10 cm above the centre of the knee.

Measured size (cm)	3mm beige	3mm gray
34-37 cm	SFX20-3B	SFX20-3G
36-39 cm	SFX23-3B	SFX23-3G
38-42 cm	SFX26-3B	SFX26-3G
41-46 cm	SFX29-3B	SFX29-3G
45-50 cm	SFX32-3B	SFX32-3G

## Cross section

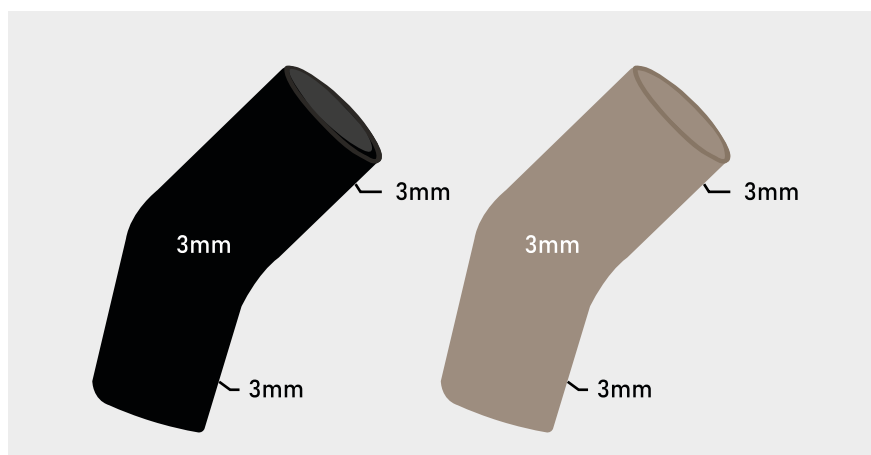

ALPS® Liner Technology

5 Elastomers. 5 Fabrics. 5 Suspensions.



# Superior Suspension Sleeve

ALPS Superior Suspension Sleeve provides superior comfort thanks to its use of ALPS Gel.

The Gel adheres to the amputee's skin to achieve secure suspension without restricting circulation and without causing shear forces.

With its thinner profile, the SFB, is the ideal choice for patients who want a lightweight product with reduced bulk.



## Material



High Density Gel



GripGel

## Fabric



Black Fabric

## Activity level



K1 ✓



K2 ✓



K3 ✓



K4 ✓

## Thickness



2 mm

## Key Benefits

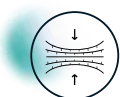

Minimizes compression and irritation proximally



The High Density Gel ensures superior control even for more active users



Provides a secure suspension of the prosthetic leg

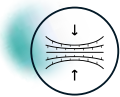

Reduced bulk thanks to its 2 mm profile



The fabric's limited vertical stretch improves control of the prosthetic leg and allows for ease of knee flexion

# Superior Suspension Sleeve SFB/SFBHD. Sizing chart

Measure the circumference of the leg at 10 cm above the centre of the knee.

Measured size (cm)	2mm uniform
25-30 cm	SFB(HD)20-2
31-34 cm	SFB(HD)24-2
35-37 cm	SFB(HD)26-2
38-40 cm	SFB(HD)28-2
41-45 cm	SFB(HD)32-2

## Cross section

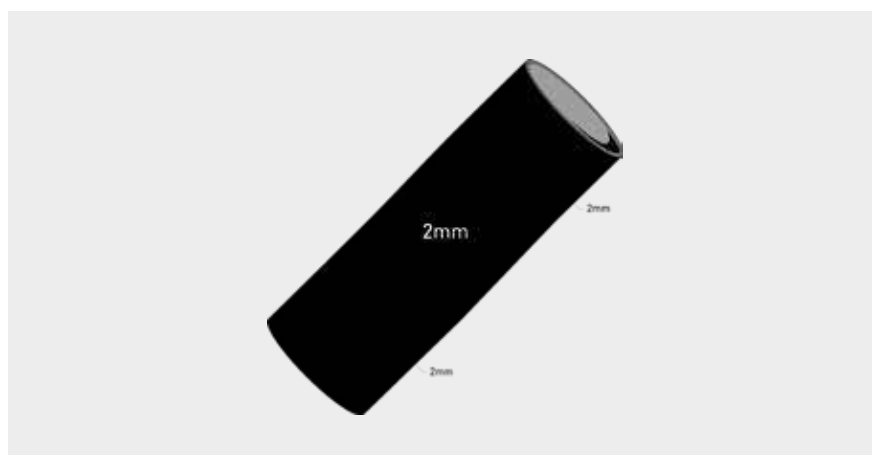

# Superior Performance Sleeve

ALPS Superior Performance Sleeve is a prosthetic gel sleeve constructed using a limited vertical stretch fabric that maintains a high horizontal elongation to provide the transtibial user with easy knee flexion and elevated control.

The Gel adheres to the patient's skin without creating shear force and helps prevent the sleeve from rolling down the residual limb.



## Material



GripGel

## Fabric



Black Fabric

## Activity level



K1 ✓



K2 ✓



K3 ✓



K4 ✓

## Thickness



3 mm

6 mm

## Key Benefits

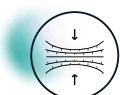

Minimizes compression and irritation proximally



The High Density Gel ensures superior control even for more active users



Provides a secure suspension of the prosthetic leg



Recommended for waterproof prostheses



The fabric's limited vertical stretch improves control of the prosthetic leg and allows for ease of knee flexion



# Superior Performance Sleeve SFP/SFPHD. Sizing chart

Measure the circumference of the leg at 10 cm above the centre of the knee.

Measured size (cm)	3mm or 6mm uniform
20-24 cm	SFP(HD)16-(3 or 6)
25-30 cm	SFP(HD)20-(3 or 6)
31-34 cm	SFP(HD)24-(3 or 6)
35-37 cm	SFP(HD)26-(3 or 6)
38-40 cm	SFP(HD)28-(3 or 6)
41-45 cm	SFP(HD)32-(3 or 6)
46-60 cm	SFP(HD)38-(3 or 6)
61-70 cm	SFP(HD)44-(3 or 6)

## Cross section

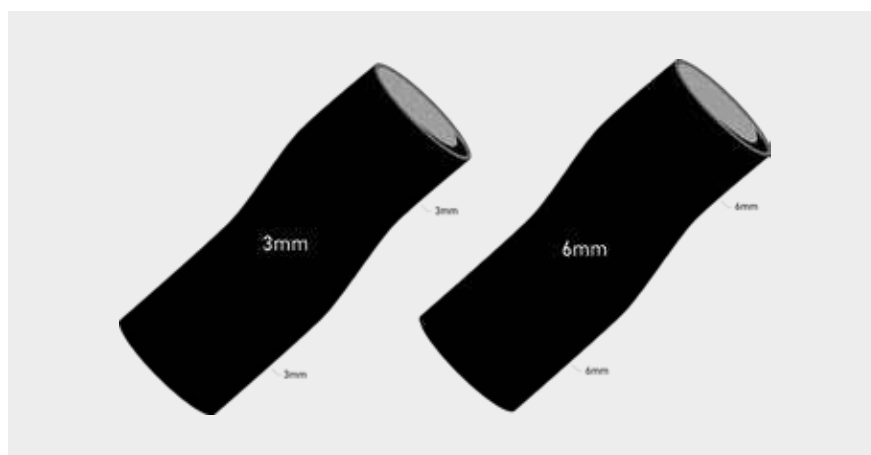

ALPS® Liner Technology

5 Elastomers. 5 Fabrics. 5 Suspensions.



# Extreme Sleeve

ALPS Extreme Sleeve is covered with a limited vertical stretch fabric that maintains a high horizontal elongation to provide the user with an easy knee flexion and elevated control.

The GripGel adheres to the patient's skin without creating shear force and helps prevent the sleeve from rolling down the residual limb.



## Material



GripGel

## Fabric



Brown Fabric

## Activity level



K1 ✓



K2 ✓



K3 ✓



K4 ✓

## Thickness



3 mm 6 mm

## Key benefits

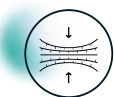

Minimizes compression and irritation proximally



Provides a secure suspension of the prosthetic leg



The fabric's limited vertical stretch improves control of the prosthetic leg and allows for ease of knee flexion

## Extreme Sleeve SFK. Sizing chart

Measure the circumference of the leg at 10 cm above the centre of the knee.

Measured size (cm)	3mm or 6mm uniform
20-24 cm	SFK16-(3 or 6)
25-30 cm	SFK20-(3 or 6)
31-34 cm	SFK24-(3 or 6)
35-37 cm	SFK26-(3 or 6)
38-40 cm	SFK28-(3 or 6)
41-45 cm	SFK32-(3 or 6)
46-60 cm	SFK38-(3 or 6)
61-70 cm	SFK44-(3 or 6)

## Cross section

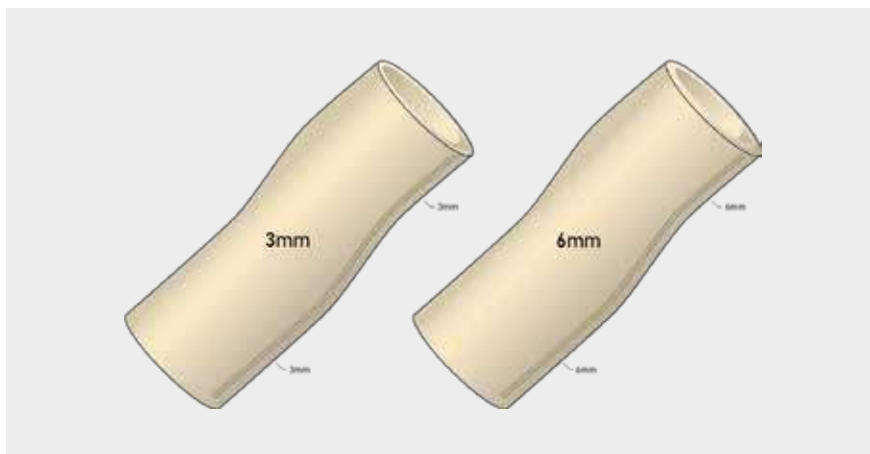

ALPS® Liner Technology

5 Elastomers. 5 Fabrics. 5 Suspensions.



# EasySleeve Fabric Reinforced

ALPS® SFS has superior comfort provided by GripGel. The elasticity of the fabric allows the user excellent freedom of knee flexion. The SFS also achieves secure suspension by sealing with the skin without restricting circulation, while the GripGel sticks to the patients skin without causing shear force.



## Material



GripGel

## Fabric



Beige  
Fabric

## Activity level



K1 ✓



K2 ✓



K3



K4

## Thickness



3 mm



6 mm

## Key benefits



Beige, high-performance fabric improves the sleeve's durability



Allows a high degree of freedom of knee flexion



Provides a secure suspension of the prosthetic leg



Minimizes compression and irritation proximally



The GripGel helps prevent the sleeve from rolling down the amputee's limb

# EasySleeve Fabric Reinforced. SFS. Sizing Chart.

Measure the circumference of the leg at 10 cm above the centre of the knee.

Measured size (cm)	3mm or 6mm uniform
20-24 cm	SFS16-(3 or 6)
25-30 cm	SFS20-(3 or 6)
31-34 cm	SFS24-(3 or 6)
35-37 cm	SFS26-(3 or 6)
38-40 cm	SFS28-(3 or 6)
41-45 cm	SFS32-(3 or 6)
46-60 cm	SFS38-(3 or 6)
61-70 cm	SFS44-(3 or 6)

## Cross section

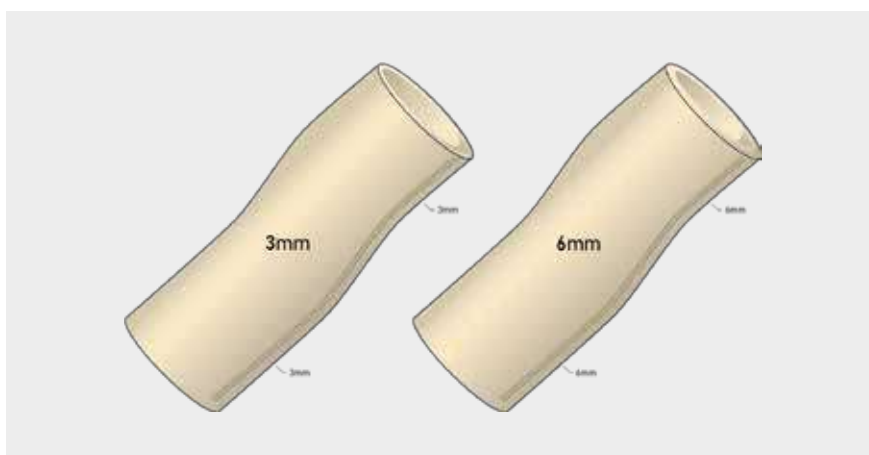

ALPS® Liner Technology

5 Elastomers. 5 Fabrics. 5 Suspensions.



# Lock with Pyramid

Patent No. 5,507,837\*

The ALPS Lock with Pyramid is an all-in-one lock body design which combines the lock and pyramid. The glass reinforced nylon lock body exhibits better wear characteristics than delrin or aluminum. The convenient one-way gear allows the user to push in or wind out the limb into the prosthetic socket. A unique feature of this lock is that if foreign material or clothing get caught in the gear, the housing can be removed, freeing the pin.



## Key benefits



For laminated sockets



All-in-one lock body design combining the lock and pyramid



Infinite pin adjustment reduces play



The housing can be removed, freeing the pin



100 kg (220 lbs) weight rating

# ALPS Lock with Pyramid. Part Number and Spare Parts

Spare parts	Description
S498-P	Main body with pyramid
LDH - 694 A	Locking mechanism
LDP - 695	Serrated pin
LDA - 694	Hex nut adapter - Dummy
FAB 946	Fabrication Kit

## Product components



1 STAINLESS STEEL SERRATED PIN  
3/8 x 2-5/8" LONG  
1/4-20 US STANDARD THREADS  
PN# LDP-695

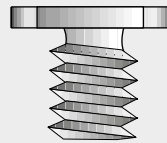

1 HEX NUT ADAPTER  
1/4-20 US STANDARD  
THREADS TO 10mm  
PN# LDA-694

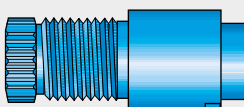

1 LOCKING MECHANISM  
(CLUTCH)  
PN# LDH-694A

# Lock with Flat Bottom





Patent No. 6,511,513\* | 6,572,656\* | 6,572,657\* | 6,576,020\* | 6,576,021\*  
6,579,323\* | 6,596,027\*

The ALPS Lock Flat Bottom has shown proven reliability and smooth operation. This lightweight locking device made of glass reinforced nylon exhibits better wear characteristics than delrin or aluminum. The convenient one-way gear allows the user to push in or wind out the limb into the prosthetic socket.

A unique feature of this lock is that if foreign material or clothing get caught in the gear, the housing can be removed, freeing the pin.



## Key benefits

-  Infinite pin adjustment reduces play
-  The housing can be removed, freeing the pin
-  For laminated or thermoplastic sockets
-  Lightweight (107gr)
-  No weight limit



## ALPS Lock Flat Bottom – Without Plate (S496-W) Part Number and Spare Parts

Spare parts	Description
S496-W	Main body with flat bottom (without plate)
LDH - 694 A	Locking mechanism
LDP - 695	Serrated pin
LDA - 694	Hex nut adapter - Dummy
FAB 946	Fabrication Kit



1 STAINLESS STEEL SERRATED PIN  
3/8 x 2-5/8" LONG  
1/4-20 US STANDARD THREADS  
PN# LDP-695

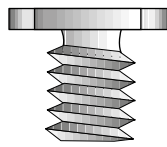

1 HEX NUT ADAPTER  
1/4-20 US STANDARD  
THREADS TO 10mm  
PN# LDA-694

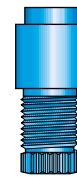

1 LOCKING MECHANISM  
(CLUTCH)  
PN# LDH-694A

## ALPS Lock Flat Bottom – With Plate (S496-T) Part Number and Spare Parts

Spare parts	Description
S496-T	Main body with flat bottom (with plate)
LDH - 694 A	Locking mechanism
LDP - 695	Serrated pin
LDA - 694	Hex nut adapter - Dummy
UMP-496	Universal Mounting Plate
FAB 946	Fabrication Kit



1 STAINLESS STEEL SERRATED PIN  
3/8 x 2-5/8" LONG  
1/4-20 US STANDARD THREADS  
PN# LDP-695

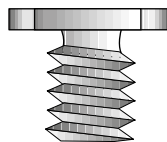

1 HEX NUT ADAPTER  
1/4-20 US STANDARD  
THREADS TO 10mm  
PN# LDA-694



1 LOCKING MECHANISM  
(CLUTCH)  
PN# LDH-694A



x1 UNIVERSAL MOUNTING  
PLATE  
PN# UMP-496



x6 STAINLESS STEEL SCREWS  
SOLD WITH MOUNTING PLATE

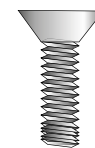

x4 3/4" STAINLESS STEEL  
SOCKET HEAD CAP SCREWS  
SOLD WITH MOUNTING PLATE

# VIP® Lock

With ALPS VIP® Lock, clinicians can quickly switch from pin & lock to vacuum suspension, or vice versa, with minor adjustments to the socket.



## Key benefits



Retrofits with ALPS VIP®



Lightweight



Removable release pin



Perfect fit with ALPS' encapsulations

## VIP® Lock Part Number and specification

PART #	VIP-L1120-S
DIMENSIONS	32x67 mm
WEIGHT	74 g
WEIGHT LIMIT	270 kg
PIN (4.8cm)	VIP-92L
PIN (3.0cm)	VIP-92S

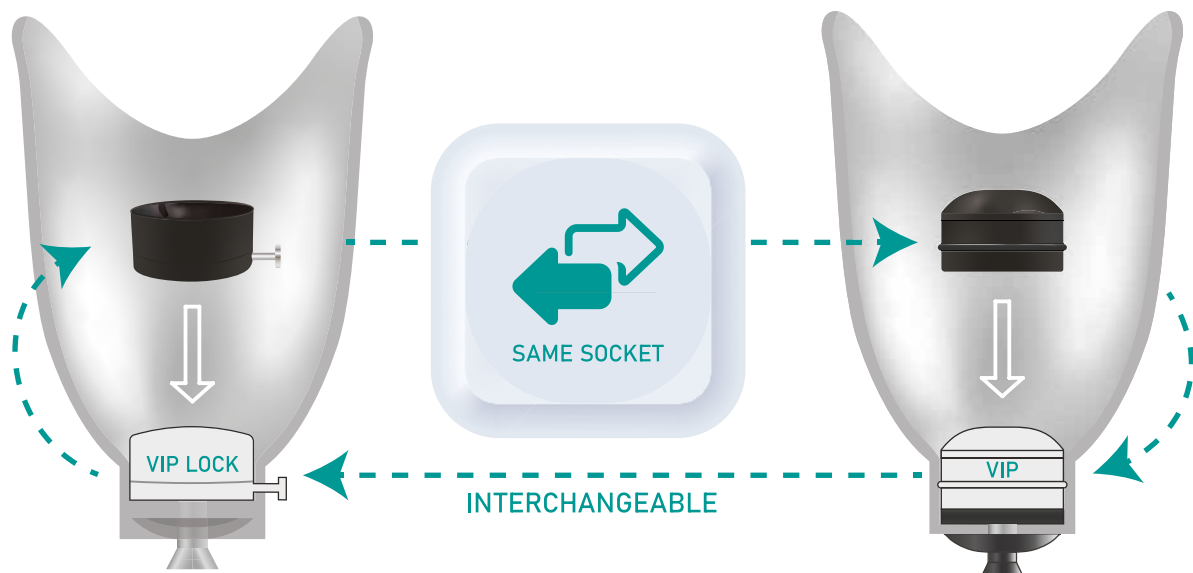

# Vacuum Integrated Pump

Patent No. 8,197,555 | 11,224,527 | 8,197,555 | 11,224,527

The ALPS VIP® is an air expulsion integrated pump for elevated vacuum. Its use provides patients continuous total contact when donning the prosthesis. This is essential for an even weight distribution and to distribute the suspension of the prosthesis over the whole surface of the residual limb. Elevated vacuum created by the VIP® stabilizes the residual limb, overcoming all issues connected with the residual limb changing volume during the day.



## Key benefits



Efficiently deals with stump volume fluctuation which in turn leads to improved prosthesis control and comfort



Reduces the intensity of peaks in pressure on the patient's limbs, improving comfort and providing greater freedom of movement



Helps preserve residual limb skin health by improving circulation and consequently increasing limb oxygenation



Quiet and light does not affect the cosmetic appearance of the prosthesis



Easy to install and battery-free

# Vacuum Integrated Pump VIP® Part Number and optional complementary products.

Available in 2 different vacuum levels: HIGH VACUUM (Red) 10-13 in of mercury and LOW VACUUM (Green) 5-8 in of mercury. Choose vacuum level on the basis of activity level and skin condition.

Part name	Part #
VIP® LOW VACUUM (GREEN)	VIP - DL
VIP® HIGH VACUUM (RED)	VIP - DH
DUMMY	VE319 - D
SMALL DUMMY	VE319 - SD
MOUNTING PLATE	VE819 - P
LOCK (SMALL)	VIP-L1120-S
MINI VALVE	MV-009
MINI VALVE KIT	LMV-009
PIN (4.8cm)	VIP-92L
PIN (3.0cm)	VIP-92S

## Cross section

### With Mounting Plate

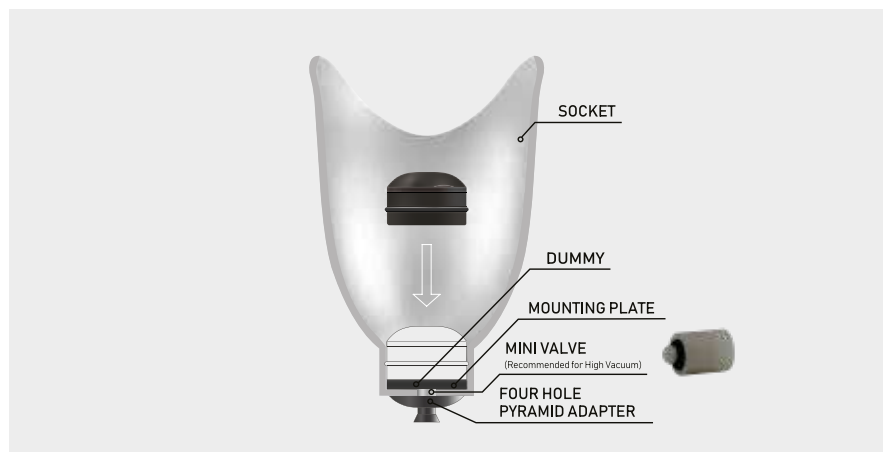

### Without Mounting Plate

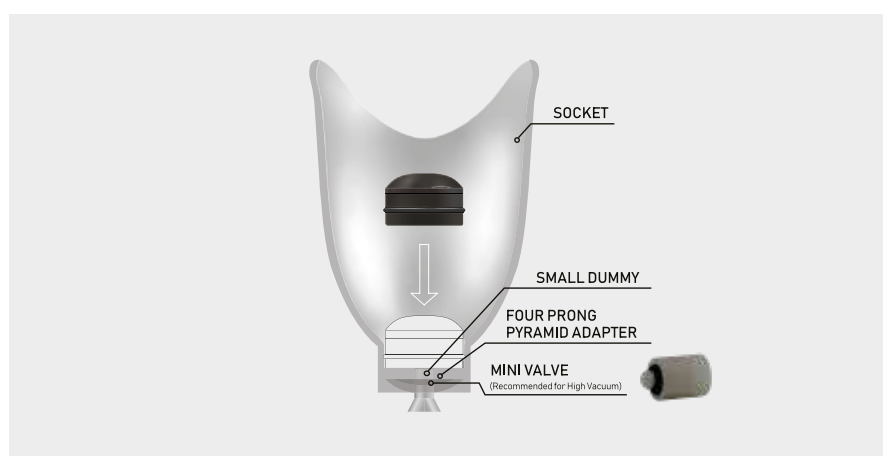

# ADDED SOLUTIONS

Modular Components

---

Volume Change  
Management

---

Liner & Residual  
Limb Care

---

Extras





# Modular Components

For transtibial and transfemoral prostheses.

## 4-hole pyramid adapter



PART ID	MATERIAL	WEIGHT	MAX. USER WEIGHT
SA401-B-T	Pyramid: Titanium Plate: Aluminum Ergal	57g	136kg
SA401-B-S	Pyramid: Stainless steel Plate: Aluminum Ergal	67g	136kg



## 4-Hole pyramid receiver adapter

PART ID	MATERIAL	WEIGHT	MAX. USER WEIGHT
SA402-A	Aluminum Ergal	53g	100kg



## Lamination anchor with pyramid

PART ID	MATERIAL	WEIGHT	MAX. USER WEIGHT
LA101-BS	Pyramid: Stainless steel Prong: Aluminum Ergal	69g	136kg
LA101-BT	Pyramid: Titanium Prong: Aluminum Ergal	58g	136kg



## Tube with pyramid receiver

PART ID	MATERIAL	WEIGHT	MAX. USER WEIGHT
TA201-AL20	Aluminum Ergal	146g	136kg
TA201-S20	Clamp: Stainless steel Tube: Aluminum Ergal	222g	136kg
TA201-T20	Clamp: Titanium Tube: Aluminum Ergal	171g	136kg
TA201-AL30	Aluminum Ergal	196g	136kg
TA201-S30	Clamp: Stainless steel Tube: Aluminum Ergal	269g	136kg
TA201-T30	Clamp: Titanium Tube: Aluminum Ergal	220g	136kg



## Tube Clamp Adapter

PART ID	MATERIAL	WEIGHT	MAX. USER WEIGHT
TCA-A	Aluminum Ergal	75g	136kg





## Double pyramid receiver adapter

PART ID	MATERIAL	WEIGHT	MAX. USER WEIGHT
TA202-75A	Aluminum Ergal	110g	136kg
TA202-60A	Aluminum Ergal	100g	136kg
TA202-45A	Aluminum Ergal	90g	136kg
TA202-32A	Aluminum Ergal	79g	136kg



## 3-Prong socket adapter with rotatable pyramid

PART ID	MATERIAL	WEIGHT	MAX. USER WEIGHT
LA103-S	Stainless steel	211g	125kg
LA107-TS	Rotary pyramid: Titanium Prong: Stainless steel	168g	125kg



## 3-Prong socket adapter with rotatable pyramid receiver

PART ID	MATERIAL	WEIGHT	MAX. USER WEIGHT
LA104-TS	Rotary receiver: Titanium Prong: Stainless steel	158g	150kg
LA108-S	Stainless steel	189g	150kg



## 4-Prong socket adapter with rotatable pyramid

PART ID	MATERIAL	WEIGHT	MAX. USER WEIGHT
LA105-S	ST	207g	125kg
LA109-TS	Rotary pyramid: Titanium Prong: ST	161g	125kg



## 4-Prong socket adapter with rotatable pyramid receiver

PART ID	MATERIAL	WEIGHT	MAX. USER WEIGHT
LA106-TS	Rotary receiver: Titanium Prong: Stainless steel	151g	150kg
LA110-S	Stainless steel	181g	150kg

# Prosthetic Socks with Hole

ALPS prosthetic socks are light and soft, extremely comfortable with a perfect fit. They are made with technologically advanced fibers, highly effective in moisture management, that wick away perspiration so it can easily evaporate. This advanced fabric means that socks maintain their original quality for a long time, without getting misshapen or matting up.

Choosing the best sock to suit your needs is easy with ALPS socks' color-coded thickness indicator: blue for 1-ply; 3-ply, yellow; 5-ply, green.

1 ply ● 3 ply ● 5 ply ●



## Key Benefits



Assists with volume fluctuation



Keeps its shape over time; minimal stretch and will not mat down



Technical fibers allow a cool, comfortable wear



Light and soft, extremely comfortable

## Prosthetic Socks KC. Sizing chart.

Measurements taken 5 cm from the distal end.

RECOMMENDED ALPS LINER SIZE	LEVEL OF AMPUTATION	PROXIMAL CIRCUMFERENCE	DISTAL CIRCUMFERENCE AT 5 CM	*LENGHT OF THE SOCKET 13-18 CM	*LENGHT OF THE SOCKET 18-23 CM	*LENGHT OF THE SOCKET 23-38 CM	*LENGHT OF THE SOCKET 38-48 CM
20	BK	min. 20 max. 40 cm	20-23 cm	KCN-8-X-Y	KCN-10-X-Y	KCN-14-X-Y	KCN-18-X-Y
24, 26, 28	BK	min. 30 max. 60 cm	23-31 cm	KCM-8-X-Y	KCM-10-X-Y	KCM-14-X-Y	KCM-18-X-Y
32, 38	AK	min. 40 max. 80 cm	31-36 cm	KCW-08-X-Y	KCW-10-X-Y	KCW-14-X-Y	KCW-18-X-Y

X indicates the thickness in Ply (1Ply= 1,5mm; 3Ply= 2mm; 5Ply=2,5mm)

Y indicates the distal end (N-without hole; H with hole; HR with reinforced hole)

### Part number examples:

KCN-08-3-H Prosthetic sock, Narrow, Extra Short, 3 Ply, with hole

KCM-10-1-N Prosthetic sock, Medium, Short, 1 Ply, without hole

KCW-18-5-HR Prosthetic Sock, Wide, Long, 5 Ply, with reinforced hole

Use our product selector to find the product code which better fits your individual needs.



# Prosthetic Socks without Hole

ALPS prosthetic socks are light and soft, extremely comfortable with a perfect fit. They are made with technologically advanced fibers, highly effective in moisture management, that wick away perspiration so it can easily evaporate. This advanced fabric means that socks maintain their original quality for a long time, without getting misshapen or matting up.

Choosing the best sock to suit your needs is easy with ALPS socks' color-coded thickness indicator: blue for 1-ply; 3-ply, yellow; 5-ply, green.



1 ply ● 3 ply ● 5 ply ●

## Key Benefits



Assists with volume fluctuation



Keeps its shape over time; minimal stretch and will not mat down



Technical fibers allow a cool, comfortable wear



Light and soft, extremely comfortable

## Prosthetic Socks KC. Sizing chart.

Measurements taken 5 cm from the distal end.

RECOMMENDED ALPS LINER SIZE	LEVEL OF AMPUTATION	PROXIMAL CIRCUMFERENCE	DISTAL CIRCUMFERENCE AT 5 CM	*LENGHT OF THE SOCKET 13-18 CM	*LENGHT OF THE SOCKET 18-23 CM	*LENGHT OF THE SOCKET 23-38 CM	*LENGHT OF THE SOCKET 38-48 CM
20	BK	min. 20 max. 40 cm	20-23 cm	KCN-8-X-Y	KCN-10-X-Y	KCN-14-X-Y	KCN-18-X-Y
24, 26, 28	BK	min. 30 max. 60 cm	23-31 cm	KCM-8-X-Y	KCM-10-X-Y	KCM-14-X-Y	KCM-18-X-Y
32, 38	AK	min. 40 max. 80 cm	31-36 cm	KCW-08-X-Y	KCW-10-X-Y	KCW-14-X-Y	KCW-18-X-Y

X indicates the thickness in Ply (1Ply= 1,5mm; 3Ply= 2mm; 5Ply=2,5mm)

Y indicates the distal end (N-without hole; H with hole; HR with reinforced hole)

### Part number examples:

KCN-08-3-H Prosthetic sock, Narrow, Extra Short, 3 Ply, with hole

KCM-10-1-N Prosthetic sock, Medium, Short, 1 Ply, without hole

KCW-18-5-HR Prosthetic Sock, Wide, Long, 5 Ply, with reinforced hole

Use our product selector to find the product code which better fits your individual needs.



# Skin Reliever

The ALPS Skin Reliever eliminates shear forces, friction, and prevents abrasions on the skin of the stump.

It also accommodates volume fluctuations over the life of the prosthesis.

There is no need to make a new socket, ALPS Skin Reliever can be worn under silicone, gel, and pelite liners.



## Key Benefits



Reduces shearing and abrasions



High elasticity



Replaces pelite and socks



Softens and soothes the skin



Contains an antioxidant for use on delicate skin

## Skin Reliever ENCP. Sizing chart.

Measure the circumference of the stump at 6 cm above the distal end.

MEASURED SIZE (CM)	ENCP 3/1.5MM TAPERED
10-19 cm	ENCP16
20-27 cm	ENCP20
28-37 cm	ENCP28

## Cross section

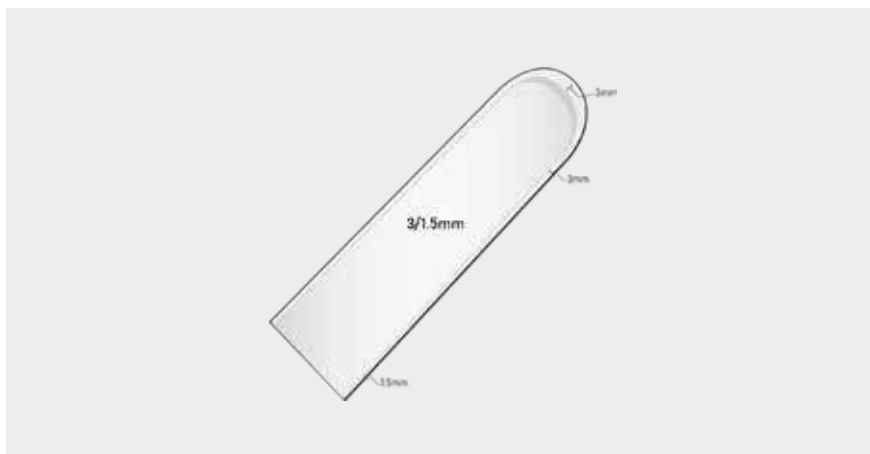

# Antioxidant Cream

Patent No. 10,543,167 | 11,478,419

ALPS Antioxidant Cream contains antioxidants that are effective scavengers of free radicals and hydroxyl groups. May assist with soothing pain, itchiness and irritated skin. Can be applied on stumps with sensitive skin as it stimulates skin regeneration process. Its moisturizing power improves skin elasticity.

Recommended for use with all liners.



## Key benefits



Soothes Pain, Itch, and Irritation

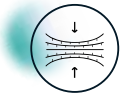

Stimulates Skin Regeneration



Improves Skin Elasticity



Great for Sensitive Skin

## Product Code

PRODUCT NO.	AMOUNT	QUANTITY
ANT-C50	50 ML	x 1
ANT-C50 BX12	50 ML	BOX OF 12



# Silicone Skin Lotion



ALPS 100% Silicone Skin Lotion helps to soothe dry, sensitive skin. It is hypoallergenic, with no perfumes or dyes, and minimal residue. Can be used sparingly to relieve dry, cracked skin conditions.

## Key benefits



Hypoallergenic and skin friendly: formulated to soothe and hydrate sensitive skins without oily feeling



Simple use: apply a few drops of lotion on the skin or on palm of the hand and massage until completely absorbed



Concentrated: a few drops are enough to relieve dry and cracked skin conditions



Without soap or dyes: 100% free of soaps and dyes that could be aggressive

## Product Code

PRODUCT NO.	AMOUNT	QUANTITY
SL 108	118 ML	x 1
SL108 BX12	118 ML	BOX OF 12
SL108-32	944 ML	x 1

# Prosthetic Lubricant

ALPS Prosthetic Lubricant is used to help in donning gel and silicone prosthetic liners. It allows the amputee to don the liner or sheath easily while eliminating the sticky feel.



## Key benefits



Helps the placement of the liner in the socket



Easy application in 3 fast steps: Turn the liner inside-out - spray the lubricant on the external surface - unroll the liner over the stump



Eliminates the sticky feeling and is recommended for use with all liners



Contains 70% isopropyl alcohol for quick evaporation

## Product Code

PRODUCT NO.	AMOUNT	QUANTITY
PA 604	443 ML	x 1
PA 604 BX12	443 ML	BOX OF 12

# Prosthetic Cleanser



ALPS Prosthetic Cleanser is a non-alkaline, soap-free cleansing agent designed to help remove dirt and excess perspiration from prosthetic liners and sleeves. Its unique formula allows it to work efficiently with hand washing or machine wash settings to effectively clean and restore items back to their original state.

## Key benefits



Developed to remove dirt and excess sweat from prosthetic liners and sleeves, either by hand or in the washing machine. It is recommended for use with all liners



Suitable for sensitive skin: thanks to its delicate formula it can also be applied to the areas of the skin that come into contact with the prosthesis



Without soap or dyes: 100% free of soaps and dyes that could be aggressive



Balanced pH: the non-alkaline silicone-based formula soothes the skin and does not damage the liner.

## Product Code

PRODUCT NO.	AMOUNT	QUANTITY
PD 595	473 ML	x 1
PD 595 BX12	473 ML	BOX OF 12

# PadSil

The Padsil was developed to increase patient comfort in combination with ALPS liners. The more active user will appreciate the additional cushioning, softness, and durability. Users who experience volume changes will also appreciate the Padsil's ability to lift the limb back into the proper position. They can be placed at the bottom of the socket or inside a pin locking liner.



## Key Benefits



Soft medical grade silicone

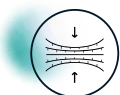

Helps maintain total contact



Keeps its shape over time



Easily modified



Blue dummy padsils are available for laminating

## PadSil PDS. Sizing chart.

Measure the circumference of the stump at 6 cm above the distal end.

MEASURED SIZE (CM)	SILICONE DISTAL PAD	BLUE DUMMY FOR LAMINATION
14-19 cm	PDS-S Ø 5,5 cm	PDSB-S
20-23 cm	PDS-M Ø 6,5 cm	PDSB-M
24-27 cm	PDS-L Ø 8 cm	PDSB-L
28-31 cm	PDS-XL Ø 9 cm	PDSB-XL
32-35 cm	PDS-XXL Ø 10,5 cm	PDSB-XXL

## Cross section



# PROSTHETIC FEET PROSTHETIC KNEE





# BioStep® EVO

Patent No. 7,410,503~ | 8,236,062~ | 8,574,314~ | 8,808,395~

## Ready for the next adventure

The most performing among the BioStep® Family. An all-around foot, with extra shock absorption and increased safety on all terrains, providing a softer connection to the ground.

Suggested for demanding dynamic users searching for the best. Ideal also for hiking and trekking, as well for recreational sport and high impact activities.

Natural, responsive, gently supportive.

With NRG  
Technology®



### Activity level



## Key Benefits



Lightweight



Physiological and energy efficient gait



Smooth rollover during the whole gait cycle



High dynamic response to support an active lifestyle



Possibility to do a wide range of activities with just one single foot



Ground compliance and stability on all terrains



Reduction of secondary issues thanks to a more balanced posture and symmetrical gait



Low maintenance



Waterproof: resistant to fresh, salt, and chlorinated water



## Technical information

Size Range: **22-30**

Build Height: **170 mm**

Heel height: **10 mm**

Weight: **840 g** (size 26 with footshell)

## Max user weight:

Size	K2 ⓘ	K3	K4
22	113kg	102kg	90kg
23-24	125kg	113kg	102kg
25-30	158kg	147kg	125kg

## Product code example

Model	Size	Side	Rate
BSEVO	25	L/R	42

Add -D for dark footshell



Footshell and spectra sock are included

## Key Features



**NRG Technology®**



**Multilayer**



**Dynamic Calf and Shin**



**Split Toe**



**Range of Motion  
26°**



**Axial Rotation 12°**



**Increased Shock Absorption**



**Waterproof**

ⓘ Indicated for more active K2 users.

Use our product selector to find the product code which better fits your individual needs.



# BioStep® PRO

Patent No. 7,410,503~ | 8,236,062~ | 8,574,314~ | 8,808,395~

## Do that extra mile!

All benefits of the NRG Technology® with enhanced torsional movement.

Suggested for active outdoor patients who prefer a firm connection to the ground and the added benefits of torsion. Also for occasional and recreational sport activities.









Natural, comfortable, responsive.



### Activity level



## Key Benefits

-  Lightweight
-  Physiological and energy efficient gait
-  Smooth rollover during the whole gait cycle
-  High dynamic response to support an active lifestyle
-  Possibility to do a wide range of activities with just one single foot
-  Ground compliance and stability on all terrains
-  Reduction of secondary issues thanks to a more balanced posture and symmetrical gait
-  Low maintenance
-  Waterproof: resistant to fresh, salt, and chlorinated water

## Technical information

Size Range: **22-30**

Build Height: **150 mm**

Heel height: **10 mm**

Weight: **730 g** (size 26 with footshell)

## Max user weight:

Size	K2 ⓘ	K3	K4
22-24	113kg	101kg	101kg
25-30	183kg	183kg	147kg

## Product code example

Model	Size	Side	Rate
BSPRO	25	L/R	42

Add -D for dark footshell



Footshell and spectra sock are included

## Key Features



**NRG Technology®**



**Multilayer**



**Dynamic Calf and Shin**



**Split Toe**



**Range of Motion  
26°**



**Axial Rotation 12°**



**Increased Shock  
Absorption**



**Waterproof**

ⓘ Indicated for more active K2 users.

Use our product selector to find the product code which better fits your individual needs.



# BioStep® CL

Patent No. 7,410,503~ | 8,236,062~ | 8,574,314~ | 8,808,395~

## Your everyday companion

Our Classic foot with all benefits of the NRG Technology®; it provides a firm connection to the ground.

Suggested for urban walkers and aggressive walkers searching for a strong, durable and comfortable dynamic response foot.

Natural and responsive.



### Activity level



## Key Benefits



Lightweight



Physiological and energy efficient gait



Smooth rollover during the whole gait cycle



High dynamic response to support an active lifestyle



Possibility to do a wide range of activities with just one single foot



Ground compliance and stability on all terrains



Reduction of secondary issues thanks to a more balanced posture and symmetrical gait



Low maintenance



Waterproof: resistant to fresh, salt, and chlorinated water

## Technical information

Size Range: **22-30**

Build Height: **150 mm**

Heel height: **10 mm**

Weight: **740 g** (size 26 with footshell)

## Max user weight:

Size	K2 ⓘ	K3	K4
22-24	113kg	101kg	101kg
25-30	183kg	183kg	147kg

## Product code example

Model	Size	Side	Rate
BSCCL	25	L/R	42

Add -D for dark footshell



Footshell and spectra sock are included

## Key Features



**NRG Technology®**



**Multilayer**



**Dynamic Calf and Shin**



**Split Toe**



**Range of Motion  
26°**



**Axial Rotation 16°**



**Increased Shock Absorption**



**Waterproof**

ⓘ Indicated for more active K2 users.

Use our product selector to find the product code which better fits your individual needs.



# BioStep® XT

Patent No. 7,410,503~ | 8,236,062~ | 8,574,314~ | 8,808,395~

## The relentless energy

Maximum energy storage and return for the most demanding patients.

Suggested for high impact activities requiring torsional movement and for occasional sports activities.

Natural, comfortable, extremely responsive.



### Activity level



## Key Benefits



Lightweight



Physiological and energy efficient gait



Smooth rollover during the whole gait cycle



High dynamic response to support an active lifestyle



Possibility to do a wide range of activities with just one single foot



Ground compliance and stability on all terrains



Reduction of secondary issues thanks to a more balanced posture and symmetrical gait



Low maintenance



Waterproof: resistant to fresh, salt, and chlorinated water

## Technical information

Size Range: **22-30**

Build Height: **185 mm**

Heel height: **10 mm**

Weight: **840 g** (size 26 with footshell)

## Max user weight:

Size	K2 ⓘ	K3	K4
22-30	152kg	140kg	120kg

## Product code example

Model	Size	Side	Rate
BSXT	25	L/R	42

Add -D for dark footshell



Footshell and spectra sock are included

## Key Features



**NRG Technology®**



**Multilayer**



**Dynamic Calf and Shin**



**Split Toe**



**Range of Motion  
26°**



**Axial Rotation 16°**



**Increased Shock Absorption**



**Waterproof**

ⓘ Indicated for more active K2 users.

Use our product selector to find the product code which better fits your individual needs.



# BioStep® LP

Patent No. 8,574,314~

## Low build height for a great freedom

The ideal solution for active users with long residual limbs. It provides secure contact with the ground, as well as responsive action and ground compliance.

Suggested for medium and high mobility users with long residual limbs, who want a responsive, all-around foot.









Responsive with low height.



### Activity level



## Key Benefits

-  Lightweight
-  Physiological and energy efficient gait
-  Smooth rollover during the whole gait cycle
-  High dynamic response to support an active lifestyle
-  Possibility to do a wide range of activities with just one single foot
-  Ground compliance and stability on all terrains
-  Reduction of secondary issues thanks to a more balanced posture and symmetrical gait
-  Low maintenance
-  Waterproof: resistant to fresh, salt, and chlorinated water



## Technical information

Size Range: **22-30**

Build Height: **68 mm**

Heel height: **10 mm**

Weight: **600 g** (size 26 with footshell)

## Max user weight:

Size	K2 ⓘ	K3	K4
22-24	100kg	88kg	77kg
25-30	165kg	147kg	130kg

## Product code example

Model	Size	Side	Rate
BSLP	25	L/R	E

Add -D for dark footshell



Footshell and spectra sock are included

## Key Features



**Split Toe**



**Range of Motion  
26°**



**Increased Shock  
Absorption**



**Waterproof**

ⓘ Indicated for more active K2 users.

Use our product selector to find the product code which better fits your individual needs.



# ProStride

An intuitive microprocessor prosthetic knee that effortlessly adapts to the patient's gait speed, enhancing mobility and independence.

ProStride™ knee is an advanced artificial joint designed to provide users with an easy-to-use, safe, comfortable, and energy-efficient walking experience.

ProStride™ includes microprocessor technology and a polycentric design, helping users easily initiate the swing phase while conserving energy, adapting to a wide range of walking conditions, and continuously adjusting to users' gait over time.

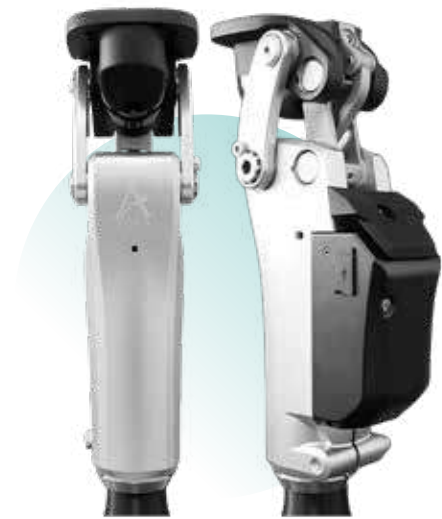

## Activity level

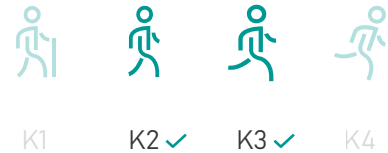

## Key Benefits



### Four-bar pneumatic design.

Allows the instant center of rotation (ICR) trajectory to mimic that of a normal gait pattern.



### Microprocessor technology.

Includes **three smart sensors** that automatically calibrate to the patient's gait pattern, making adjustments quick and accurate.



### Smart programming.

Thanks to a **user-friendly app**, programming the ProStride can be completed within minutes with just a few simple inputs.



### Easy to use.

The ProStride is designed to be user-friendly, enabling practitioners of all experience levels to install and program it efficiently, while users can easily manage it.



### Customization options.

In the app, users have the opportunity to easily customize the knee's response to meet a specific activity need (biking, hiking, etc.) without affecting the initial programming settings.

## Specifications

MATERIAL	Aluminum alloy (mainly), Stainless steel
SYSTEM WEIGHT	1.260 gr / 2.78 Lbs
MAX FLEXION ANGLE	142°
MAX BODY WEIGHT	125 Kg / 275 Lbs
PROXIMAL CONNECTION	For connection with standard 4-hole adaptor
PYLON DIAMETER	30 mm
ACTIVITY LEVEL	K2, K3
COMPATIBLE SOFTWARE	Mobile app compatible with Android Version 9+ and iOS Version 13+
BATTERY LIFE	Up to 3 days under normal usage

## Dimensions

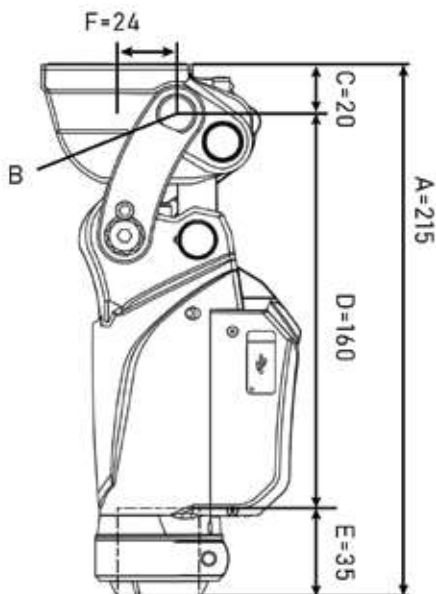

- A System Height
- B Alignment Reference Point
- C Proximal build height up to the alignment reference point
- D Distal build height up to the alignment reference point
- E Tube insertion length
- F Centro-Bolt to Alignment Reference

Note: All measurements in mm



## HOW TO SIZE LINERS

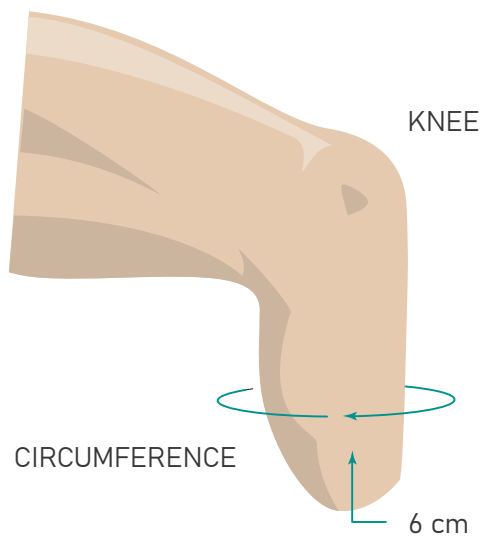

Measure the circumference of the stump at 6 cm above the distal end. Use the chart in the product page to select the size of the liner.

## HOW TO SIZE SLEEVES

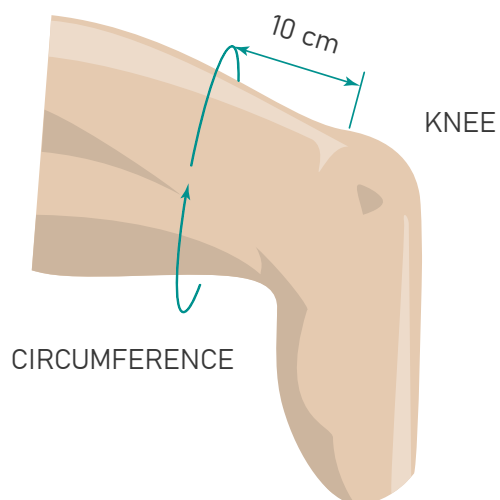

Measure the circumference of the leg at 10 cm above the centre of the knee. Use the chart in the product page to select the size of the sleeve.

# ALPS WARRANTY POLICY

\*\*\* All products are backed by a 30 day no questions asked warranty policy

## LINERS

ITEM	DESCRIPTION	WARRANTY
AKDT/AKDTHD/ AKFR/AKFRHD	Extreme™ Liner	12 Months
APDT-TP/APFR-TP	Anterior-Posterior Tapered Liner	12 Months
ECDTHD/ECFRHD	Eco™ Liner	12 Months
ELDT/ELFR	EasyLiner®	12 Months
ELPX	EasyLiner® Super Stretch	6 Months
EZF	EasyFlex™ Liner	12 Months
GPDT/GPFR	General Purpose Liner	12 Months
LSL/LSC	Silicone Pro Liner	12 Months
PFGDT/PFGFR	Pro-Fit Liner	12 Months
PSI	Proximal Seal Interface Liner	6 Months
SAFR/SADT/SBFR	Smart Seal™ Liner	6 Months
SPDT/SPDTHD/SPFR/SPFRHD	Superior Performance Liner	12 Months
SSGSL/SSGSC	SoftSil Liner	12 Months
USHSL/USHSC/USLSL/USLSC/USUSL/USUSC	UltraSeal Silicone Liner	6 Months
USHGL/USHGC/USLGL/USLGC/USUGL/USUGC	UltraSeal Gel Liner	6 Months
VSDT	Liberty™ Liner	12 Months

## SLEEVES

ITEM	DESCRIPTION	WARRANTY
RFS	Fabric Reinforced Sleeve	3 Months
RFX	Fabric Reinforced Flex Sleeve	3 Months
SFB/SFBHD	Superior Suspension Sleeve	3 Months
SFK	Extreme Sleeve	3 Months
SFP/SFPHD	Superior Performance Sleeve	3 Months
SFR	Easy Sleeve	3 Months
SFS	EasySleeve Fabric Reinforced	3 Months
SFX	Flex Sleeve	3 Months
SLE	Easy Sleeve Super Stretch	3 Months

## LOCKS

ITEM	DESCRIPTION	WARRANTY
S498-P	ALPS Lock with Pyramid	6 Months
S496-W	ALPS Lock Flat Bottom - Without Plate	6 Months
S496-T	ALPS Lock Flat Bottom - With Plate	6 Months
VIP® Lock		6 Months

## EXTRA

ITEM	DESCRIPTION	WARRANTY
ENCP	Skin Reliever	1 Month
KC	Prosthetic Socks	1 Month
PDS	Silicone Distal Pad	6 Months
VIP®	Vacuum Integrated Pump	6 Months
Modular Components		2 Years

## SKIN CARE

ITEM	DESCRIPTION	WARRANTY
ANT-CEP50	Antioxidant Cream	90 Days
PA604	Prosthetic Lubricant	90 Days
PD595	Prosthetic Cleanser	90 Days
SL108	Skin Lotion	90 Days

## FEET AND KNEES

ITEM	WARRANTY
BioStep® EVO, BioStep® PRO, BioStep® CL, BioStep® XT, BioStep® LP	3 Years
Foot Shell	6 Months
Spectra Sock	1 Month
ProStride	3 Years

# CONTACTS



Tel +420 377 223 127  
Fax +420 377 223 010  
info@easyliner.eu  
www.easyliner.eu

## ALPS WORLDWIDE OFFICES

### ALPS USA

Tel 727-528-8566  
infous@easyliner.com  
www.easyliner.com

### ALPS CHINA

Tel 0731-55582976-801  
china\_salesrep@easyliner.com.cn  
www.easyliner.com.cn

### ALPS ITALY

Tel +39 051 86 06 42  
info@alpsitaly.com  
www.easyliner.eu

### ALPS EUROPE

Tel +420 377 223 127  
info@easyliner.eu  
www.easyliner.eu

### ALPS UKRAINE

Tel +38(067) 889 80 22  
alpsukraine@easyliner.eu  
www.alpsukraine.com

Use of <sup>TM</sup> and <sup>®</sup> herein is limited to trademark claims and registrations in the European Union





Even the highest performing prosthetic device will be inadequate without a perfect interface with the residual limb to provide comfort all day long.

This is why for almost 30 years ALPS has been dedicated to designing and manufacturing only the highest-quality prosthetic liners to provide users with all the mobility they need.

Thanks to its dedication to innovation, ALPS has developed other high-quality prosthetic solutions in addition to prosthetic liners, inspired by the slogan which has been driving the company since 1988:

**Making Lives Better™**

